

ELECTRO-MECH SCOREBOARD CO.

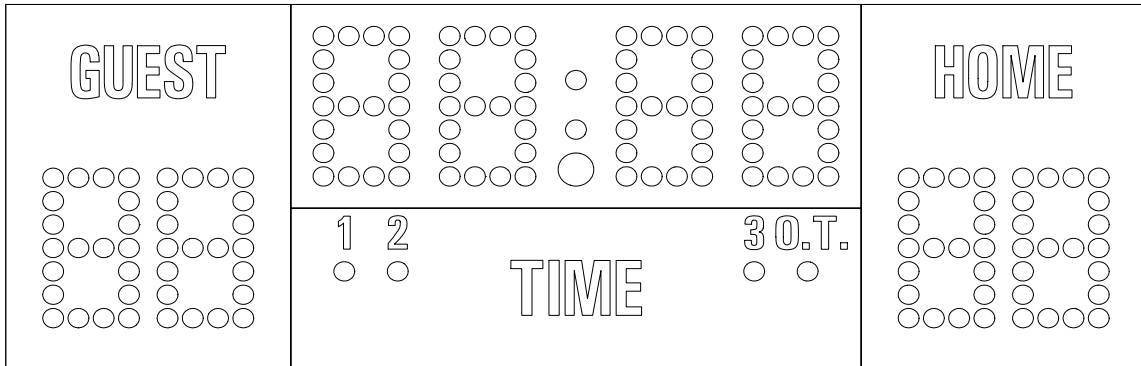

MP-9450 HOCKEY SCOREBOARD

OWNER'S HANDBOOK

Thank you for choosing an Electro-Mech Scoreboard for your athletic complex. We are confident that your new scoreboard will give many years of reliable service.

Rev. 1 Revised: 03/18/05

TABLE OF CONTENTS

HOCKEY SCOREBOARD SPECIFICATIONS.....	3
SCOREBOARD INSTALLATION.....	4
POSITIONING THE POSTS	4
MOUNTING HARDWARE.....	7
MOUNTING THE OPTIONAL TOP SPONSOR PANEL.....	8
MOUNTING THE SCOREBOARD	9
ELECTRICAL CONNECTIONS	10
Ground Connection	10
Connecting The Scoreboard To Your Power Source	10
Installing The Horn	13
ScoreLink 300	14
Installing The Control Cable	14
Connecting The Control Console	15
SCOREBOARD OPERATION	16
SERVICING THE SCOREBOARD	20
PLUG IN MODULE REPLACEMENT.....	21
LAMP REPLACEMENT	21
WARRANTY.....	22

HOCKEY SCOREBOARD SPECIFICATIONS

GENERAL: This ETL listed scoreboard includes the scoreboard cabinet, mounting hardware, control console, control cable (sold separately), 10 ft. extension cable, and junction box.

DIMENSIONS: MP-9450: 133" L x 35" H x 6" D, MP-9450 with side sponsor panel: 168" L x 35" H x 6" D

WEIGHT: MP-9450: 145 lbs, MP-9450 with sponsor panel: 165 lbs

SCOREBOARD CONSTRUCTION: The outer frame is made from extruded aluminum. Internal structural parts may be extruded aluminum or formed from aluminum sheet. The face and back are made from aluminum sheet. The face is finished with enamel paint. Black is the standard face color. White is the standard color for the sponsor panel and captions. Mounting hardware is included.

DISPLAY: The scoreboard displays HOME and GUEST scores to 99, a 99:00 clock with 1/10th of a second timing, and periods.

LAMP BANKS: A 4 x 7 matrix of lamps forms each 15" digit. Two lamps form the BONUS indicators, two lamps form the possession indicators, and four lamps form the quarter indicators. The scoreboard uses 15 watt 120 VAC frosted medium based appliance lamps (also known as 15A15IF lamps). Recessed aluminum reflectors provide a crisp separation between each lamp. Expanded metal screens protect the lamps.

POWER REQUIREMENTS: **Scoreboard** - 120 VAC, 20.75 A, 60 Hz, 2490 watts maximum, (30 A service recommended). The scoreboard may be connected to either 120 VAC or 240 VAC single phase. **Control Console** - 120 VAC, 0.5 A, 60 Hz

SCOREBOARD ELECTRONICS: 100% solid state fully enclosed within two plug in modules.

CONTROL CONSOLE: The microprocessor control console is constructed of a rugged plastic housing with a metal back plate. It features a 37 key sealed membrane keypad, a LCD display of game information, an attached 6 foot power cord, and a lithium cell battery backup to retain game information.

CONTROL CABLE: The cable has two 22 AWG stranded copper conductors with semi-rigid PVC insulation. It also has a braided shield and a foil shield. The polyethylene jacket is rated at 300 volts. The cable is direct burial rated and measures approximately ¼" in diameter. One length is required to run from the scoreboard to the point of operation (conduit installation recommended).

JUNCTION BOX AND EXTENSION CABLE: A 4 ¼" x 2 ¼" x 2" junction box with a stereo jack mounted on the face is attached to the control cable at the point of operation. A ten foot extension cable connects the control console to the junction box.

WARRANTY: Five year limited warranty.

SCOREBOARD INSTALLATION

Installation of the MP-9450 Scoreboard consists of positioning the posts, mounting the scoreboard cabinet on the posts, and making the proper electrical connections.

Items not provided by Electro-Mech Scoreboard Company which are necessary for installation:

- Two posts
- Power cable to connect the scoreboard to your power source
- Grounding hardware
- A grounded NEMA 5-15R 120 VAC receptacle for the control console.

Items not provided which are recommended by Electro-Mech Scoreboard Company for installation:

- A weatherproof power disconnect at the scoreboard
- A weatherproof NEMA 5-15R 120 VAC convenience receptacle at the scoreboard

While Electro-Mech Scoreboard Company does not perform installations, we will make every effort to answer your installation questions. Installation should be performed by qualified personnel. Consult national and local codes before installation.

POSITIONING THE POSTS

The scoreboard is designed to be mounted on two posts. We suggest that the front of the scoreboard should be angled away from the afternoon sun, if possible. Typically installers will use steel pipes or I-beams. The mounting hardware will accommodate posts up to 4.5 inches outer diameter. We recommend that the posts are sunk in reinforced concrete footings. Figure 1 shows the spacing of the posts for a MP-9450. It suggests one possible installation for a MP-9450 in silty sand soil. **No dimensional data in this manual is intended to be specifications except the size of the scoreboard cabinet and the distance between the posts.** The specifications for the posts and concrete footings are dependent upon the expected local wind and soil conditions, the height of the scoreboard from the ground, and the local building codes. Electro-Mech Scoreboard Company assumes no responsibility for the installation of scoreboards by others.

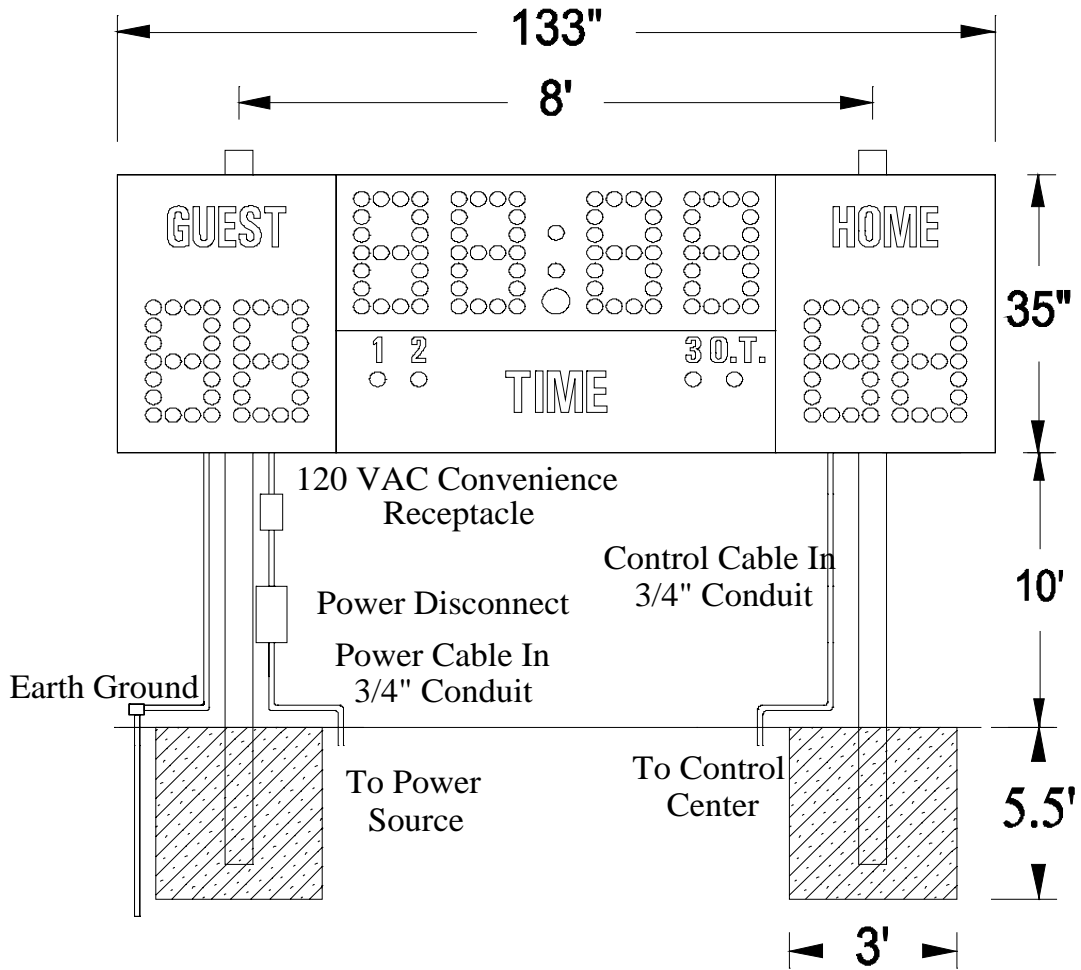

Figure 1 MP-9450 Post Spacing

Figure 2 shows the spacing of the posts for a MP-9450 with an optional side sponsor panel.

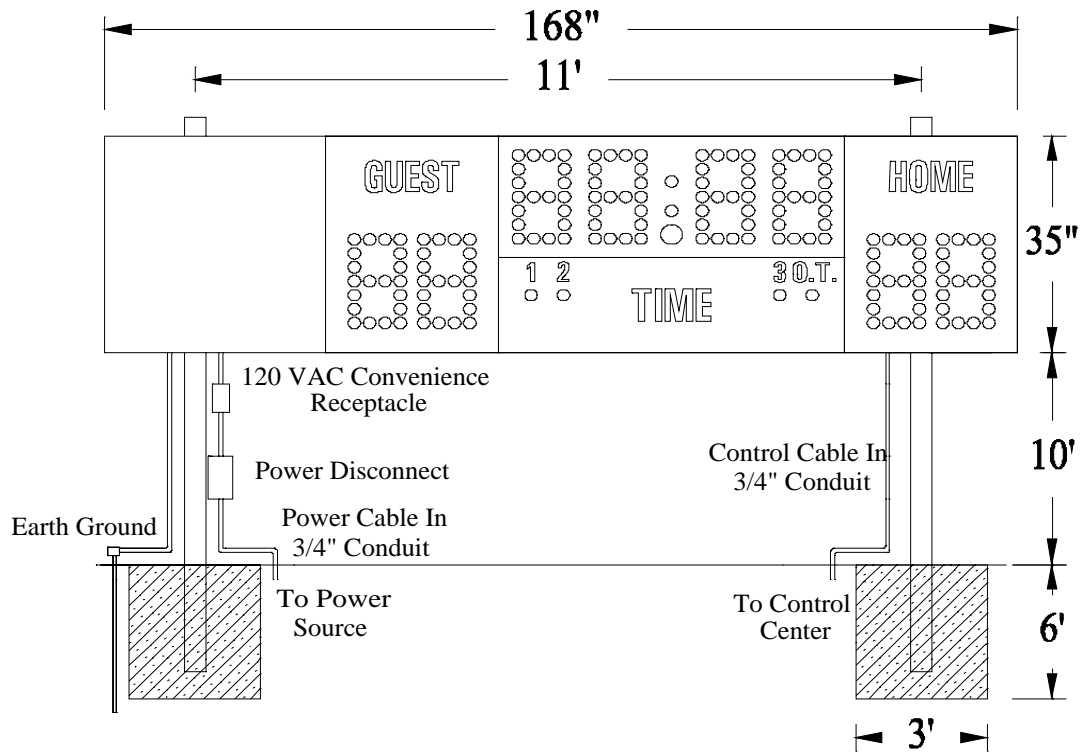

Figure 2 MP-9450 with Optional Side Sponsor Panel Post Spacing

Figure 3 shows the spacing of the posts for a MP-9450 with an optional top sponsor panel.

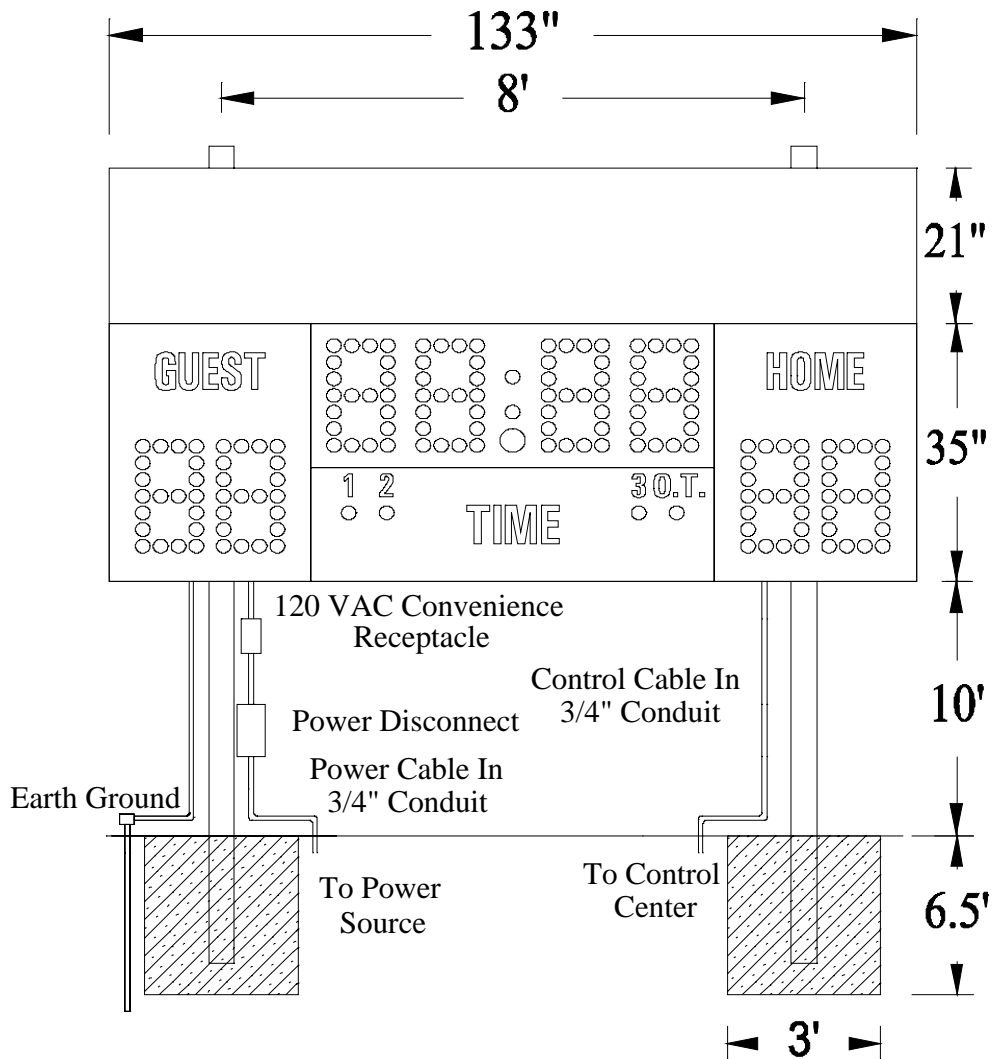

Figure 3 MP-9450 with Optional Top Sponsor Panel Post Spacing

MOUNTING HARDWARE

Four sets of mounting hardware are provided to attach the scoreboard to the posts. Additional hardware sets are provided to attach the optional sponsor panels, if ordered. A mounting hardware set consists of a steel angle bracket, two threaded rods, two washers, and two nuts. Figure 4 shows an overhead cross section view and a side cross section view of the scoreboard attached to a post at a mounting point using the hardware. A steel bracket is riveted to the scoreboard's aluminum extrusion frame. The bracket has two tapped holes. The threaded rods screw into these tapped holes. The washers and nuts are used to clamp the steel angle bracket against the steel post and hold the scoreboard in place.

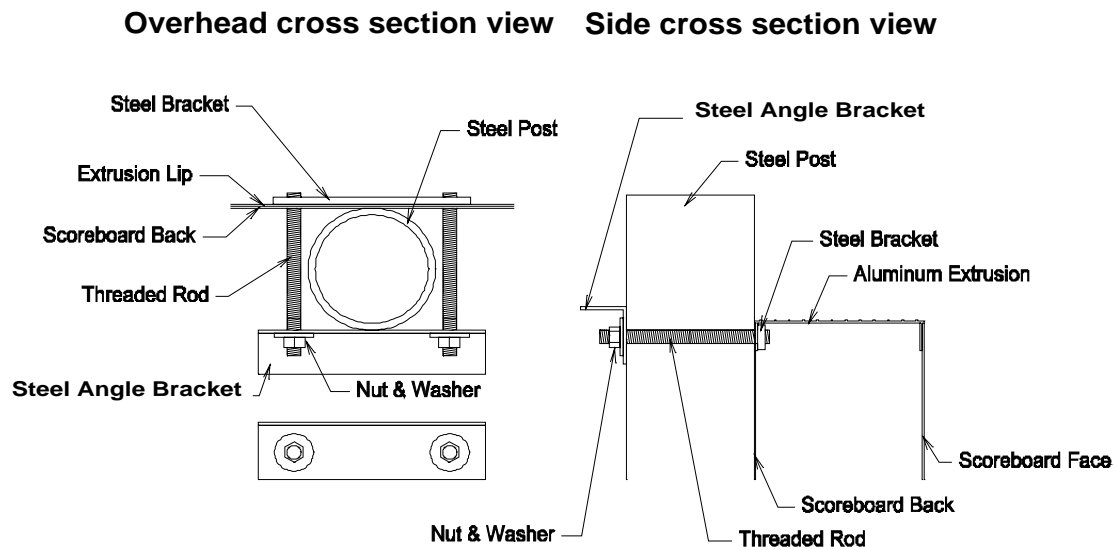

Figure 4 Standard Mounting Method

MOUNTING THE OPTIONAL TOP SPONSOR PANEL

The following steps describe how to mount the top sponsor panel on the posts:

1. Place the top sponsor panel against the posts on the ground. Make sure the mounting points are aligned with the posts.
2. Screw the threaded rods into the tapped holes in the top sponsor panel.
3. Place a steel angle bracket over the threaded rods at a mounting point.
4. Place a washer over each threaded rod.
5. Screw the nuts onto the threaded rods so that the bracket is **loosely** held in place.
6. Repeat steps 4 -6 at the other mounting points.
7. Raise the top sponsor panel into place and tighten the nuts to clamp it in place on the posts.

MOUNTING THE SCOREBOARD

The scoreboard is attached to the posts at four points. Figure 5 shows the location of the mounting points on the rear of the scoreboard.

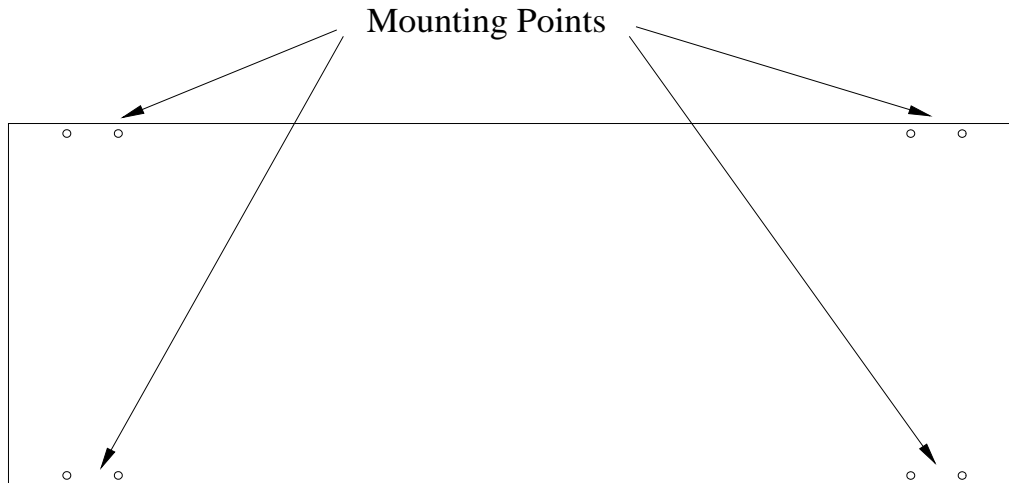

Figure 5 Mounting Points

The following steps describe how to mount the scoreboard on the posts:

1. Place the scoreboard cabinet against the posts on the ground. Make sure the mounting points are aligned with the posts.
2. Screw the threaded rods into the tapped holes in the scoreboard.
3. Place a steel angle bracket over the threaded rods at a mounting point.
4. Place a washer over each threaded rod.
5. Screw the nuts onto the threaded rods so that the bracket is **loosely** held in place.
6. Repeat steps 4 -6 at the other mounting points.
7. Raise the scoreboard into place and tighten the nuts to clamp the scoreboard in place on the posts.

ELECTRICAL CONNECTIONS

We recommend a qualified electrician perform the needed electrical connections to ensure proper operation of your scoreboard. These connections include grounding the scoreboard, connecting the scoreboard to a power source, installing the control cable, and connecting the control console.

Ground Connection

The National Electrical Code **requires** a scoreboard (electric sign) to be grounded. Grounding the scoreboard helps the scoreboard electronics operate properly and helps minimize damage if it is struck by lightning. Metal posts do **not** provide an adequate ground path when they are placed in concrete. One method of grounding is to connect the scoreboard to one or more grounding rods which are driven into the ground near the scoreboard via a large gauge copper wire. The self tapping sheet metal screws on the back of the scoreboard cabinet provide a convenient connection point.

Connecting The Scoreboard To Your Power Source

The scoreboard may be connected to 240 VAC single phase or 120 VAC service at the scoreboard. **Maximum power consumption of Model MP-9450: 2490 Watts.** Make sure that the power cables are rated for this electrical load. Electro-Mech Scoreboard Company recommends that your power cable is installed in conduit. **Avoid** running your power cables in close proximity to your control cable. The following steps describe how to connect the scoreboard to your power source:

1. Remove the hex head screws which hold the rear access panel in place (Figure 6).

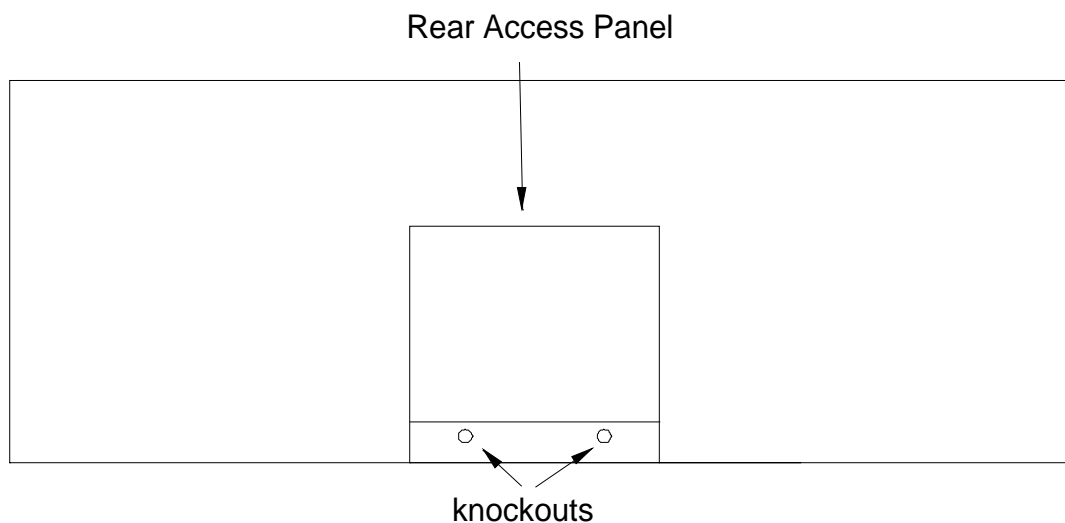

Figure 6 Rear Access Panel

Figure 7 shows the view behind the access panel.

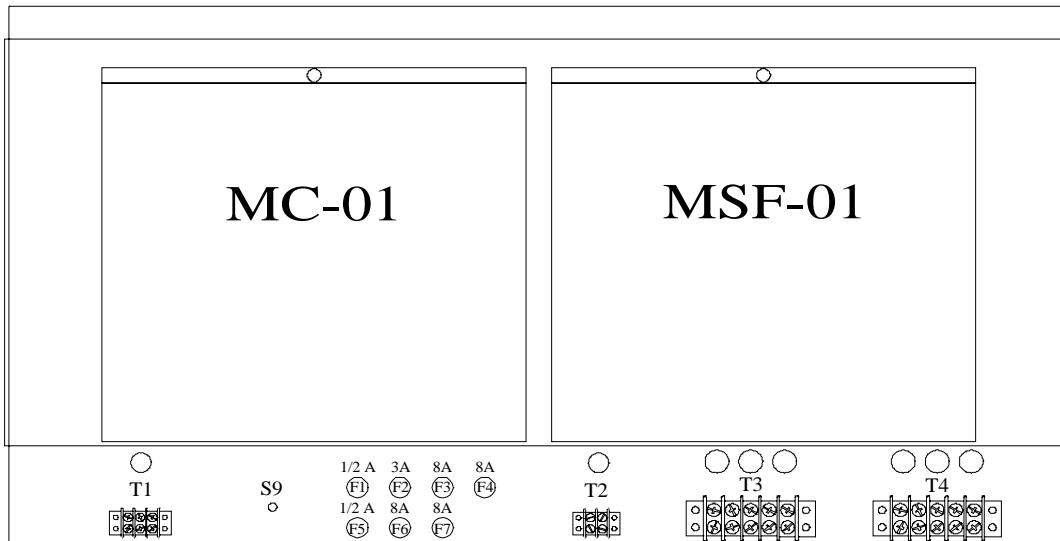

Figure 7 Access Panel Removed

2. Punch out the knockouts for the power and control cables.
3. Feed the power cables through a knockout.
4. If you are going to connect the scoreboard to a 240 VAC supply, connect one AC line wire to position 2, AC neutral wire to position 3, and the other AC line wire to position 4 of terminal strip T4 on the junction chassis according to figure 8.

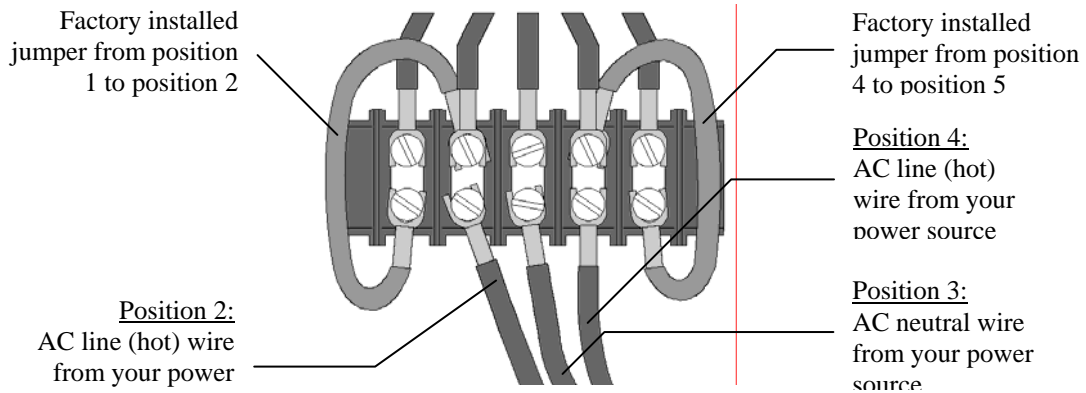

Figure 8 240 VAC Connections

5. If you are going to connect the scoreboard to a 120 VAC supply, connect the AC line wire to position 2 and the AC neutral wire to position 3 of terminal strip T3 on the junction chassis. Add a jumper from position 2 to position 4. **This jumper is not provided.** Refer to figure 9.

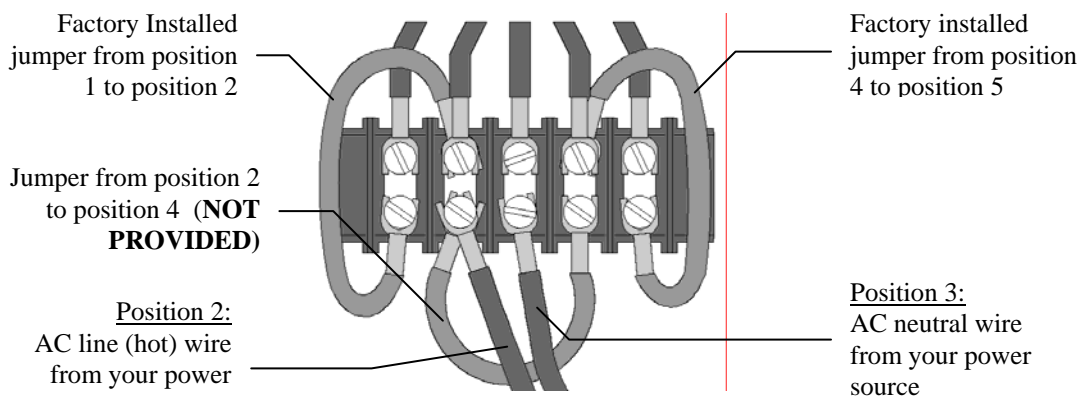

Figure 9 120 VAC Connections

Electro-Mech Scoreboard Company suggests that you install a power cut-off switch and a NEMA 5-15R receptacle in a weatherproof box on the scoreboard post below the scoreboard. The cut-off switch provides a convenient way of turning the scoreboard off during maintenance or repairs. The NEMA 5-15R receptacle will allow a technician to easily plug in the control console and operate the scoreboard via the test jack S-9 (a valuable trouble-shooting aid).

Installing The Horn

The items provided to install the horn are the horn, the mounting bolt, and the mounting bracket. Items which are not provided but are necessary for proper installation are ¾" flexible conduit, a two ¾" male conduit connectors, a ¾" straight male conduit connector, two wires, two forked crimp terminals, and two butt splice connectors. The electrical requirements for the horn are 0.35 A 120 VAC. The horn is mounted to the top of the scoreboard. A tapped hole is provided to fasten the horn to the scoreboard. The mounting bolt is screwed into the tapped hole at the factory. The following steps describe the assembly and mounting of the horn:

1. Cut a piece of ¾" conduit of sufficient length to reach from the horn mounting point to one of the knockouts below the access panel.
2. Attach the conduit connectors to the ends of the conduit.
3. Cut two pieces of wire of approximately 4 feet longer than the conduit.
4. Push the wires through the conduit.
5. Peel the tape off the horn projector.
6. Remove the plastic bag from inside the horn projector.
7. Remove the four screws that fasten the horn and horn projector to the weatherproof back box.
8. Feed the two wire leads that are attached to the rear side of the horn through one of the threaded holes on the side of the weatherproof back box. Two of the holes will accept a ¾" conduit connector.
9. Plug the other two threaded holes with the plugs from the plastic bag.
10. Splice the horn wire leads to the two wires that run through the conduit with the butt splice connectors.
11. Screw the conduit connector into the threaded hole on the weatherproof back box.
12. Attach the horn and horn projector to the weatherproof back box using the four screws.
13. Fasten the horn assembly to the scoreboard using the mounting bolt from the scoreboard.
14. Crimp forked terminals on the ends of the two wires that protrude out of the other end of the conduit.
15. Pass the wires through one of the knockouts below the access panel.
16. Fasten the conduit connector to the knockout panel and connect the wires to T-2 behind the access panel.

ScoreLink 300

The SCORELINK 300 RF MODEM SET is intended to eliminate the control cable between the scoreboard and the control console on Electro-Mech Scoreboard MM and MP series scoreboards. If you have purchased this option, disregard the next section of this manual. Refer to the SCORELINK 300 RF MODEM SET OWNER'S HANDBOOK for installation instructions.

Installing The Control Cable

The control cable connects the scoreboard to the control console. While the control cable is direct burial rated, Electro-Mech Scoreboard Company recommends that it is installed in conduit to protect it from being cut. A small junction box with a stereo jack mounted on the face plate is attached to the control cable at the point of operation of the scoreboard. This junction box should be securely mounted in a clean, dry area within ten feet of the rear of the control console. Most customers order the control cable with the junction box attached. Some customers prefer to attach the junction box after the cable is installed. Those customers must match their stereo jack to one of the stereo jacks in figure 10 in order to make the proper connections. These connections should be soldered.

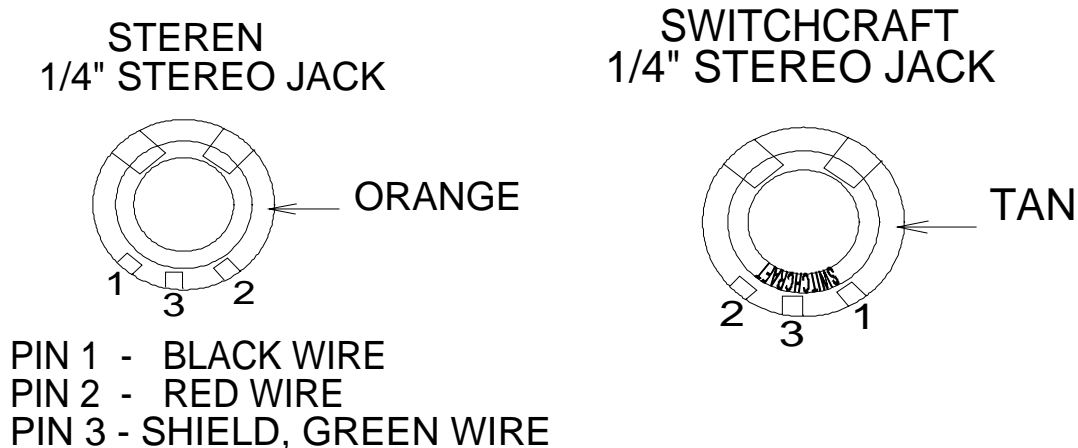

Figure 10 STEREO JACK WIRING DIAGRAM

The following steps describe how to connect the control cable to the scoreboard:

1. At the rear of the scoreboard feed the control cable through one of the knockouts below the access panel.
2. Crimp fork terminals to the control cable wires and the shield.
3. Connect the control cable to terminal strip T1 (located to the left of the test jack S9) according to the diagram in figure 11.

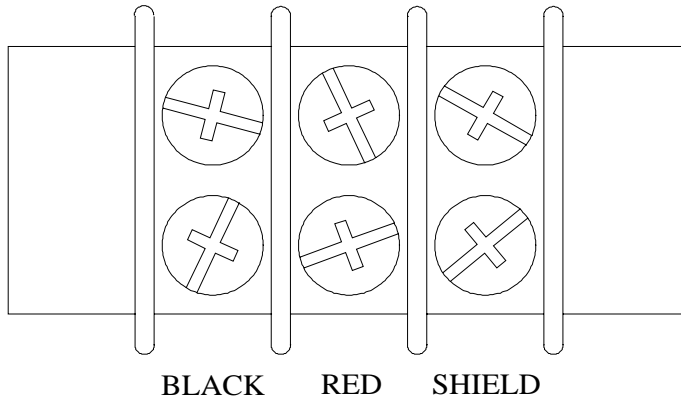

Figure 11 T1 WIRING DIAGRAM

Connecting The Control Console

The control console is normally connected to the junction box via the 10 ft. extension cable. This extra length of cable allows the scoreboard operator some mobility and the ability to store the control console after the game. The extension cable has two molded stereo plugs attached to it. One end of the extension cable is plugged into the junction box stereo jack and the other end is plugged into the stereo jack mounted on the control console back plate. The control console power cord is plugged into a grounded NEMA 5-15R 120 VAC receptacle.

This product is equipped with a 3-wire grounding type plug, a plug having a third (grounding) pin. This plug will only fit into a grounding-type power outlet. This is a safety feature. If you are unable to insert the plug into the outlet, contact a qualified electrician to replace your obsolete outlet. Do not defeat the purpose of the grounding-type plug.

SCOREBOARD OPERATION

The MP-9450 Scoreboard is operated by the control console. **No scoreboard functions will operate without connecting the control console.** Figure 12 shows the keypad layout on your control console. The keypad functions are described in the text below the figure.

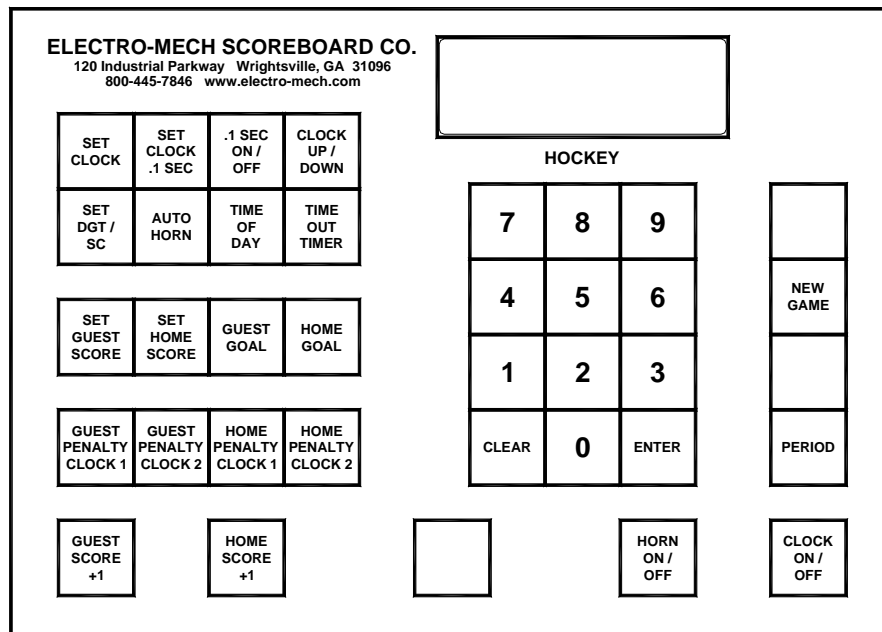

Figure 12 Keypad Layout

Control Console Key Functions

1. **SET CLOCK** – This key sets the time displayed on the scoreboard clock. Press [SET CLOCK], the keypad numbers for the time, [ENTER]. Example: Press [SET CLOCK], [6], [0], [0], [0], [ENTER] on the control console. 60:00 will be displayed on the clock section of the scoreboard.
2. **SET CLOCK .1 SEC** – This key is used when the clock is in the 1/10th second mode. Press [SET CLOCK .1 SEC], the keypad numbers for the time, [ENTER]. Example: Press [SET CLOCK .1 SEC], [5], [3], [8], [ENTER] on the control console. 53.8 will be displayed on the clock section of the scoreboard.

3. **.1 SEC ON OFF** – This key is used to enable or disable the 1/10th second mode on the scoreboard. This mode is enabled when the control console is turned on. If it is disabled, the LCD display on the control console will still show 1/10th second timing, but the scoreboard will not display it. To turn this function off, press [.1 SEC ON/OFF]. The console LCD display will read:

CLOCK ON - 1
.1 SEC OFF - 0

Press [0], [ENTER] on the control console.

4. **CLOCK UP / DOWN** – The clock can be set up to either count up or count down. The control console will reset to the clock down mode when it is turned on. To make the clock count up, press [CLOCK UP / DOWN]. The console LCD display will read:

GAME UP - 1
CLOCK DOWN - 0

Press [0], [ENTER] on the control console. To reset the clock to count down mode, press [CLOCK UP / DOWN], [1], [ENTER] on the control console.

5. **AUTO HORN** – This key allows the operator to control the end of period horn and / or the time out horn. The horn normally sounds for two seconds when the clock reaches 0:00. The end of period horn can be disabled by pressing [AUTO HORN].

GAME PRESS <1> ON
HORN PRESS <0> OFF

The console LCD display will read:

Press [0], [ENTER] to disable the horn. The console LCD display will then read:

T-O PRESS <1> ON
HORN PRESS <0> OFF

The time out horn is normally disabled. To enable the horn to sound at the end of the time out, press [1], [ENTER] on the control console.

6. **TIME OF DAY** – The time of day can be displayed on the clock section of the scoreboard. **THE GAME CLOCK WILL BE INOPERABLE UNTIL THE TIME OF DAY FUNCTION IS TURNED OFF.** To turn the time of day clock on, press [TIME OF DAY]. The console LCD display will read:

TIME OF	ON	<1>
DAY CLOCK	OFF	<0>

Press [1], [ENTER] on the control console. The console LCD display will then read:

SET CLK	<__:__>
---------	---------

Press the keypad numbers for the time, [ENTER]. The scoreboard will display the time of day.

7. **SET GUEST SCORE** – To set the guest score, press [SET GUEST SCORE], the keypad numbers for the time, [ENTER]. **EXAMPLE:** To set the guest score to 53, press [SET GUEST SCORE], [5], [3], [ENTER].
8. **SET HOME SCORE** – To set the home score, press [SET HOME SCORE], the keypad numbers for the time, [ENTER]. **EXAMPLE:** To set the home score to 75, press [SET HOME SCORE], [7], [5], [ENTER].
9. **GUEST GOAL** – This key is used to indicate that the guest team has scored a goal.
10. **HOME GOAL** – This key is used to indicate that the home team has scored a goal.
11. **GUEST SCORE +1** – This key increments the guest score by one point.
12. **HOME SCORE +1** – This key increments the home score by one point.
13. **HORN ON/OFF** – This key is used to sound the horn for ½ second.
14. **CLOCK ON/OFF** – This key is used to start and stop the clock.
15. **DIMMER** – This key will dim all the scoreboard lamps.
16. **NEW GAME** – This key is used to reset all the scoreboard functions to their default settings. To reset the scoreboard, press [NEW GAME]. The console LCD display will read:

RESET	YES	<1>
SCOREBOARD	NO	<0>

Press [1], [ENTER] on the control console. The scoreboard will reset its functions.

17. **PERIOD** – This key increments the period indicators.

18. **CLEAR** – This key clears the information being entered into the control console.

The SET SHOT TIMER, TIME OUT TIMER, GUEST PENALTY CLOCK 1, GUEST PENALTY CLOCK 2, HOME PENALTY CLOCK 1, and HOME PENALTY CLOCK 2 keys are not used with the MP-9450 scoreboard.

You should reset the scoreboard each time that it is turned on. Test out all the functions to ensure that the scoreboard is operating properly. **Electro-Mech Scoreboard Company strongly advises that you unplug the control console, disconnect the extension cable at the control console, and turn the power to the scoreboard off when the scoreboard is not in use. The control console can not turn the scoreboard off.** This action will help protect the scoreboard and control console from power surges and lightning strikes.

SERVICING THE SCOREBOARD

While your scoreboard was designed for years of trouble-free operation, some problems may occasionally occur. Our trained personnel at Electro-Mech Scoreboard Company are ready to answer your questions from Monday to Friday during the hours of 8 AM to 5 PM Eastern Standard Time. Be sure to know your scoreboard model number when calling. Scoreboard replacement parts, including lamps, are always available. Electro-Mech Scoreboard Company can repair the control console and plug in module at a significant savings when compared to the price of new units. Our convenient toll free number is listed at the bottom of every page in this manual.

As seen in figure 13, the plug in modules MSF-01 and MC-01 are located behind the rear access panel.



Figure 13 Access Panel Components

The plug in module MSF-01 operates GUEST SCORE, HOME SCORE. The plug in module MC-01 operates the CLOCK, horn, and the PERIOD indicators.

The table below lists the fuses, the fuse ratings, and their functions.

FUSES

FUSE	RATING	FUNCTION
F1	1/2 A 250 V	CONTROL LINE
F2	3 A 250 V	HORN
F3	8 A 250 V	SECONDS
F4	8 A 250 V	MINUTES
F5	1/2 A 250 V	CONTROL LINE
F6	8 A 250 V	GUEST SCORE
F7	8 A 250 V	HOME SCORE

CONNECTION POINTS

TERMINAL STRIP	FUNCTION
T-1	control cable connection
T-2	horn connection
T-3	MOV (surge protection)
T-4	power cable connection
S-9	test jack

PLUG IN MODULE REPLACEMENT

The plug in modules are located behind the rear access panel. Each module has four bottom plugs that mate with sockets in the scoreboard. A screw located at the top of the module holds it against the scoreboard cabinet. Simply remove the screw and pull the module upward to unseat the module. **To avoid damage to the plug in module, always turn off the power to the scoreboard when removing or replacing it.**

LAMP REPLACEMENT

Replacing lamps may be the only service you ever perform on your Electro-Mech scoreboard. The lamps are accessed by removing the protective mask covering each lamp bank. **To avoid damage to the plug in module, always turn off the power to the scoreboard when changing lamps.** We recommend using a felt pen or tape to mark lamps that will not light. This scoreboard uses 15 watt medium base lamps (also called 15A15 lamps). **Never replace these with higher wattage lamps.**

ELECTRO-MECH SCOREBOARD CO. FIVE YEAR LIMITED WARRANTY

THE ELECTRICAL COMPONENTS OF ALL ELECTRO-MECH SCOREBOARDS ARE GUARANTEED FOR A PERIOD OF FIVE (5) YEARS FROM THE DATE OF INVOICE AGAINST DEFECTS IN WORKMANSHIP OR MATERIAL AND WILL BE REPLACED OR REPAIRED WITHOUT COST TO THE OWNER PROVIDED THE EQUIPMENT OR PARTS ARE RETURNED POSTAGE-PAID TO THE FACTORY IN WRIGHTSVILLE, GA. SHIPPING BACK TO THE OWNER WILL BE VIA UPS GROUND SERVICE EXCEPT WHEN AIR OR SPECIAL METHOD OF RETURN IS SPECIFIED BY THE OWNER, IN WHICH CASE SHIPPING WILL BE FREIGHT COLLECT.

EXCLUDED FROM THIS WARRANTY ARE LAMPS, FUSES AND SOCKETS.

THIS WARRANTY DOES NOT INCLUDE LABOR CHARGES INCURRED IN THE REMOVAL OF COMPONENT PARTS, SERVICE CALLS, OR DAMAGES RESULTING FROM IMPROPER INSTALLATION, IMPROPER OPERATION, OR PROBLEMS CAUSED BY ANY REPAIR, ALTERATION OR MODIFICATION OF THE SCOREBOARD NOT PERFORMED BY ELECTRO-MECH.

EQUIPMENT WHICH IS SUBJECTED TO ACCIDENT, NEGLIGENCE, ABUSE, MISUSE OR OTHER NATURAL DISASTERS, INCLUDING BUT NOT LIMITED TO FIRE, WIND, LIGHTNING, OR FLOOD, IS NOT COVERED BY THIS GUARANTEE.