

ELECTRO-MECH SCOREBOARD CO.

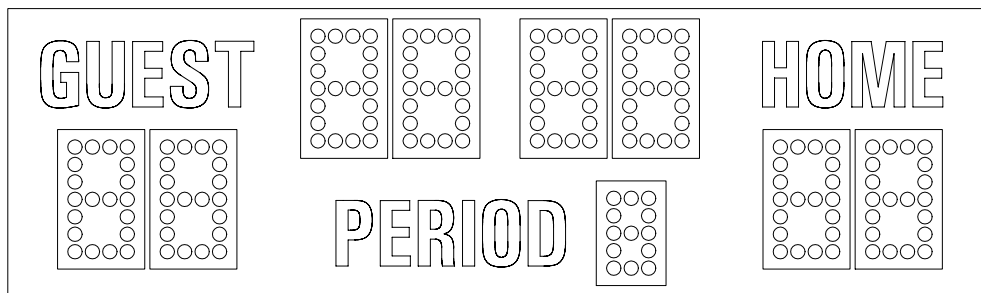

MP-363 SOCCER SCOREBOARD

OWNER'S HANDBOOK

Thank you for choosing an Electro-Mech Scoreboard for your athletic complex. We are confident that your new scoreboard will give many years of reliable service.

Rev. 2 Revised: 06/29/2006

TABLE OF CONTENTS

MP-363 SCOREBOARD SPECIFICATIONS.....	3
SCOREBOARD INSTALLATION	4
MECHANICAL INSTALLATION.....	4
Post Installation.....	4
Mounting The Scoreboard	7
Mounting The Optional Top Sponsor Panel	9
ELECTRICAL INSTALLATION.....	10
Ground Connection	10
Power Connections.....	10
Horn Installation.....	13
ScoreLink 300.....	14
Control Cable Installation.....	14
Control Console Connections	15
Control Console Safety Warning.....	15
SCOREBOARD OPERATION.....	16
SCOREBOARD STARTUP	16
GAME TIME OPERATION.....	16
Control Console Key Functions.....	17
Hand Held Clock Control Unit Operation	20
SCOREBOARD SHUTDOWN.....	21
SERVICING THE SCOREBOARD.....	22
COMPONENT REPLACEMENT	22
Lamp Replacement	22
Plug In Module Replacement.....	23
WARRANTY	24

MP-363 SCOREBOARD SPECIFICATIONS

GENERAL: This ETL listed scoreboard includes the scoreboard cabinet, mounting hardware, control console, 10 ft. extension cable, and junction box.

DIMENSIONS: 10' L x 3' H x 6" D (MP-363 with side sponsor panel: 13' L x 3' H x 6" D)

WEIGHT: MP-363: 185 lbs (MP-363 with side sponsor panel: 220 lbs)

SCOREBOARD CONSTRUCTION: The scoreboard consists of two sections. The outer frame is made from extruded aluminum. Internal structural parts may be extruded aluminum or formed from aluminum sheet. The face and back are made from aluminum sheet. The face and expanded metal screens are finished with enamel paint. Black is the standard color. Captions are white.

DISPLAY: The MP-363 scoreboard displays HOME and GUEST scores to 99, TIME to 99 minutes and 59 seconds (99:59), and PERIOD to 4.

LAMP BANKS: A 4 x 7 matrix of lamps forms each 18" digit. The TIME, HOME score, and GUEST score are 18" tall. A 3 x 5 matrix of lamps forms the 12" PERIOD digit. The scoreboard uses 15 watt 120 VAC frosted medium based appliance lamps (also known as 15A15IF lamps). Recessed aluminum reflectors provide a crisp separation between each lamp. Expanded metal screens protect the lamps.

POWER REQUIREMENTS: Scoreboard - 120 VAC, 21.6 A, 60 Hz, 2595 watts maximum, (30 A service recommended). The scoreboard may be connected to either 120 VAC or 240 VAC single phase. **Control Console** - 120 VAC, 0.5 A, 60 Hz

SCOREBOARD ELECTRONICS: 100% solid state fully enclosed within 2 plug in modules.

CONTROL CONSOLE: The control console features a microprocessor, 37 key sealed membrane keypad, a LCD display, an attached 6 foot power cord. The console housing consists of ABS plastic base and top pieces with a steel back plate.

CONTROL CABLE: The cable has two 22 AWG stranded copper conductors with semi-rigid PVC insulation. It also has a braided shield and a foil shield. The polyethylene jacket is rated at 300 volts. The cable is direct burial rated and measures approximately 1/4" in diameter. This item is sold separately from the scoreboard.

JUNCTION BOX AND EXTENSION CABLE: A 4 1/4" x 2 1/4" x 2" junction box with a 1/4" stereo jack mounted on the face plate is attached to the control cable at the point of operation. A 10 ft. extension cable connects the control console to the junction box.

SCORELINK 300 RF MODEM SYSTEM: This accessory can be used in place of control cable and junction box for this scoreboard without internal modifications to the scoreboard or the control console. Refer to the SCORELINK 300 RF MODEM SYSTEM OWNER'S HANDBOOK for more information.

WARRANTY: Five year limited warranty.

SCOREBOARD INSTALLATION

This part of the manual describes the mechanical and electrical installation of the scoreboard.

One of the items listed below must be purchased in order to complete the installation:

- Control cable (length dependent upon installation site layout)
- ScoreLink 300 RF Modem System

Items not provided by Electro-Mech Scoreboard Company that are necessary for installation:

- Two posts
- Power cable to connect the scoreboard to the power source
- Grounding hardware
- A grounded NEMA 5-15R 120 VAC receptacle for the control console at the scorekeeper's table.

Items not provided that are recommended by Electro-Mech Scoreboard Company for installation:

- A weatherproof power disconnect at the scoreboard
- A weatherproof NEMA 5-15R 120 VAC convenience receptacle at the scoreboard.

Electro-Mech Scoreboard Company performs installations in some areas. In other areas, we can help you contact an independent installer. In areas in which installation service is not available from Electro-Mech Scoreboard Company, we will make every effort to answer your installation questions. Qualified personnel should perform the scoreboard installation. Consult national and local codes before installation.

MECHANICAL INSTALLATION

The mechanical installation includes installing the posts and mounting the scoreboard and the optional top sponsor panel (if purchased) to the posts.

Post Installation

The scoreboard mounts on two posts. Typically installers will use steel pipes or I-beams. In order to reduce the glare from the sun on the front of the scoreboard, position the posts so that the front of the scoreboard is angled away from the afternoon sun, if possible. The mounting hardware will accommodate posts up to 4.5 inches outer diameter. Sink the posts in reinforced concrete footings. Figure 1 shows the spacing of the posts for a MP-363. The specifications for the posts and concrete footings are dependent upon the expected local wind and soil conditions, the height of the scoreboard from the ground, and the local building codes. Electro-Mech Scoreboard Company assumes no responsibility for the installation of scoreboards by others.

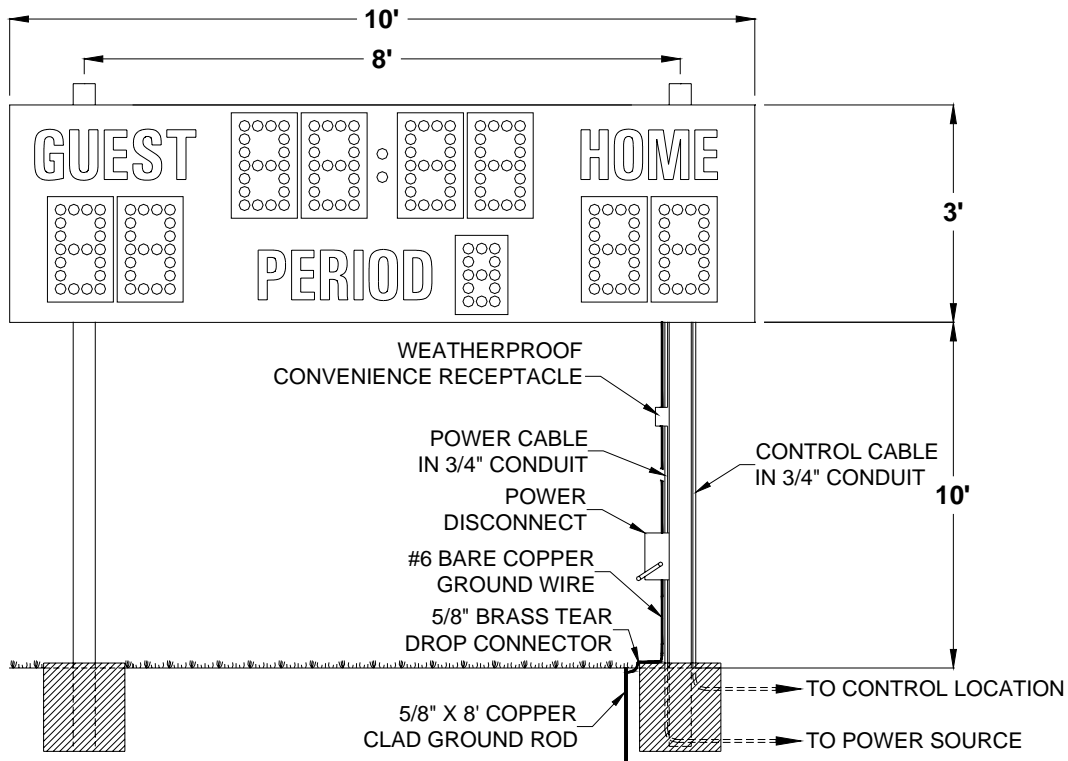

Figure 1 MP-363 Post Spacing

Figure 2 shows the spacing of the posts for a MP-363 with an optional side sponsor panel. The sponsor panel is built into the scoreboard cabinet.

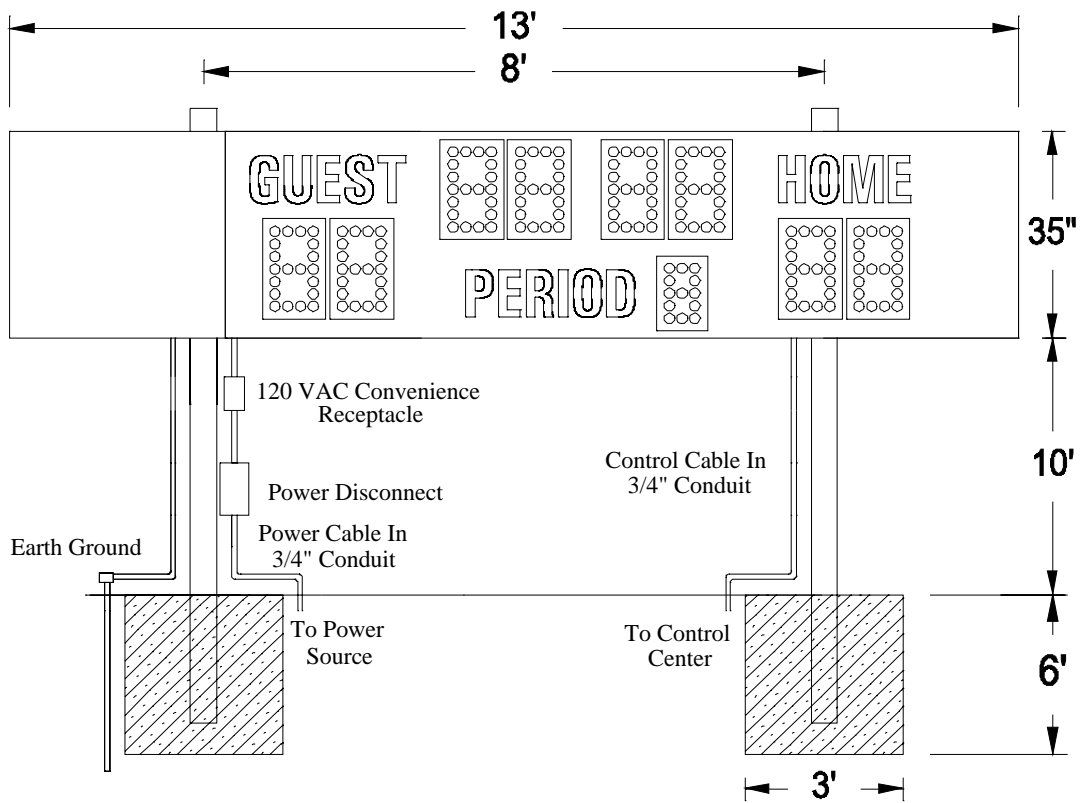

Figure 2 MP-363 with Optional Side Sponsor Panel Post Spacing

Figure 3 shows the spacing of the posts for a MP-363 with an optional top sponsor panel. This panel is a separate unit that mounts on the same posts as the scoreboard.

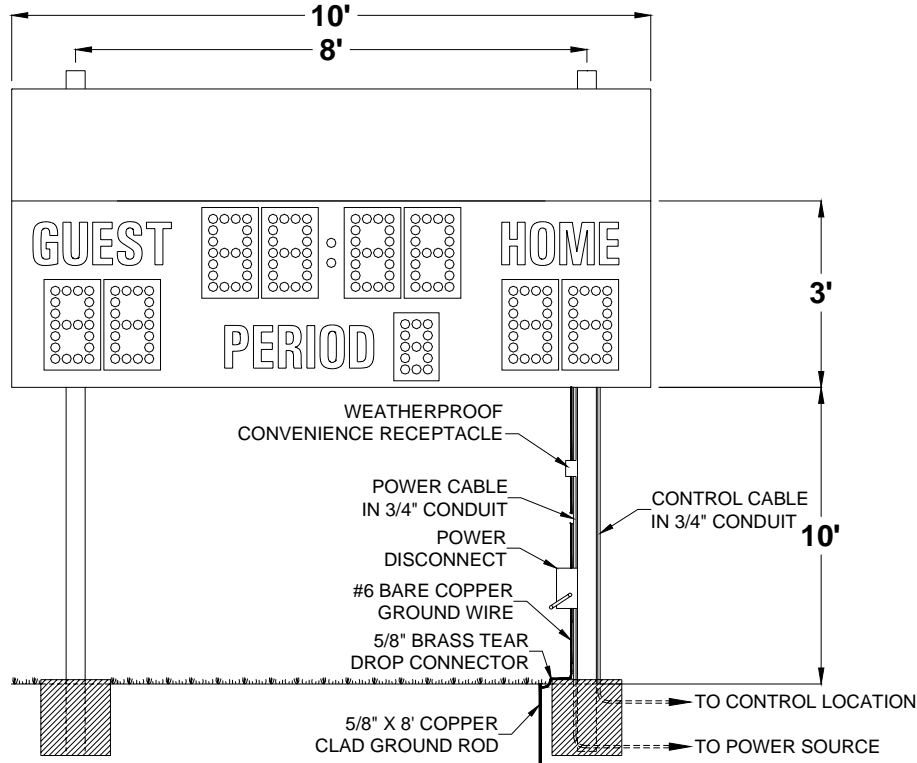

Figure 3 MP-363 with Optional Top Sponsor Panel Post Spacing

Mounting The Scoreboard

The scoreboard is attached to the posts at four points. Figure 4 shows the location of the mounting points on the rear of the scoreboard.

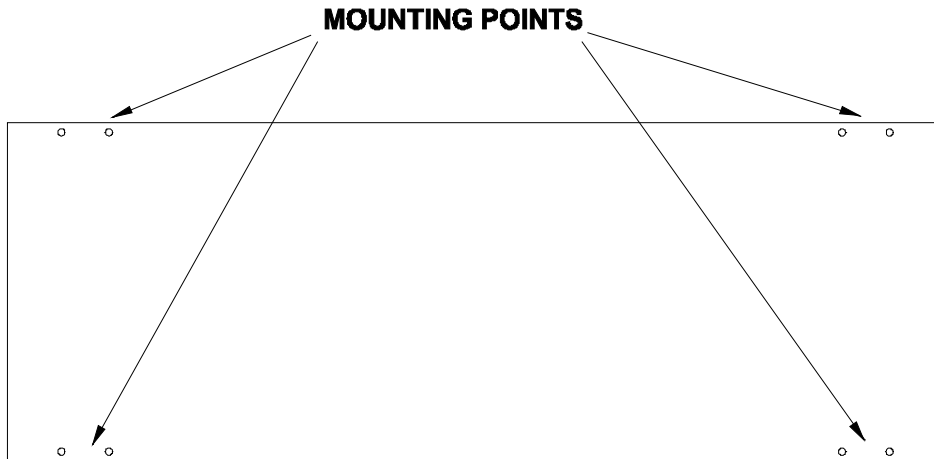

Figure 4 Mounting Points

Four sets of mounting hardware are provided to attach the scoreboard to the posts. A mounting hardware set consists of a steel angle bracket, two threaded rods, two washers, and two nuts. Figure 5 shows an overhead cross section view and a side cross section view of the scoreboard attached to a post at a mounting point using the hardware. A 1/4" flat bar with tapped holes is riveted to the inside of the scoreboard's aluminum extrusion frame. The threaded rods screw into these tapped holes. The washers and nuts are used to clamp the steel angle bracket against the steel post and hold the scoreboard in place.

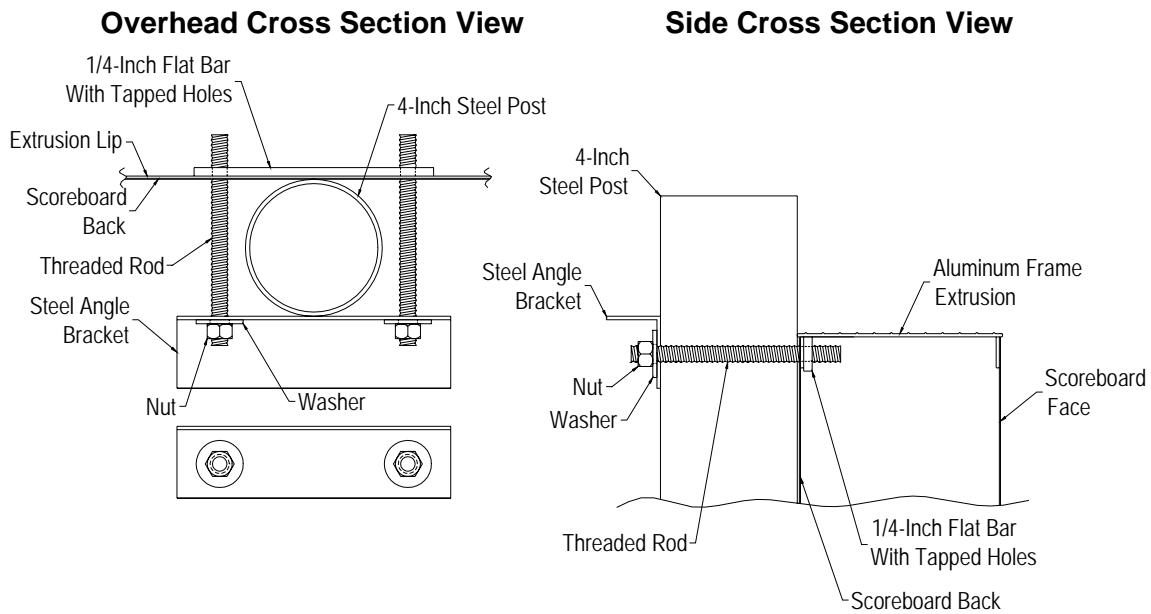

Figure 5 Standard Mounting Method

The following steps describe how to mount the scoreboard on the posts:

1. Place the scoreboard cabinet against the posts on the ground. Make sure the mounting points are aligned with the posts.
2. Screw the threaded rods into the tapped holes in the scoreboard.
3. Place a steel angle bracket over the threaded rods at a mounting point.
4. Place a washer over each threaded rod.
5. Screw the nuts onto the threaded rods so that the bracket is loosely held in place.
6. Repeat steps 4 -6 at the other mounting points.
7. Raise the scoreboard into place and tighten the nuts to clamp the scoreboard in place on the posts.

Note: Be sure to leave enough space on the posts above the scoreboard for the optional top sponsor panel, if purchased.

Mounting The Optional Top Sponsor Panel

Additional hardware sets are provided to attach the optional top sponsor panels, if purchased. The following steps describe how to mount the top sponsor panel on the posts:

1. Raise the sponsor panel in place above the scoreboard. Make sure the mounting points are aligned with the posts.
2. Screw the threaded rods into the tapped holes in the top sponsor panel.
3. Place a steel angle bracket over the threaded rods at a mounting point.
4. Place a washer over each threaded rod.
5. Screw the nuts onto the threaded rods so that the bracket is loosely held in place.
6. Repeat steps 4 -6 at the other mounting points.
7. Tighten the nuts to clamp it in place on the posts.

ELECTRICAL INSTALLATION

We recommend a qualified electrician perform the needed electrical connections to ensure proper operation of the scoreboard. These connections include grounding the scoreboard, connecting the scoreboard to a power source, installing the horn, installing the ScoreLink 300 or the control cable, and connecting the control console.

Ground Connection

The National Electrical Code **requires** a scoreboard (electric sign) to be grounded. Grounding the scoreboard helps the scoreboard electronics operate properly and helps minimize damage if it is struck by lightning. Metal posts do **not** provide an adequate ground path. The following steps describe how to connect the scoreboard to the power source:

1. Drive one or more 5/8" x 8' copper clad ground rods in the soil near the scoreboard.
2. Connect #6 bare copper wire to the ground rods using 5/8" brass tear drop connectors.
3. Attach the ground conductor to the each section of the scoreboard with copper mechanical lugs. Fasten the mechanical lugs to the scoreboard using self tapping sheet metal screws.

Power Connections

The scoreboard may be connected to 240 VAC single phase or 120 VAC service at the scoreboard. **Maximum power consumption of Model MP-363: 2595 Watts.** Make sure that the power cables are rated for this electrical load. Install the power cable in conduit. **Avoid** running the power cable in close proximity to the control cable. The following steps describe how to connect the scoreboard to the power source:

1. Remove the rear access panel and the dome plugs on the plate below the access panel. Figure 6 shows the location of the rear access panel and the dome plugs.

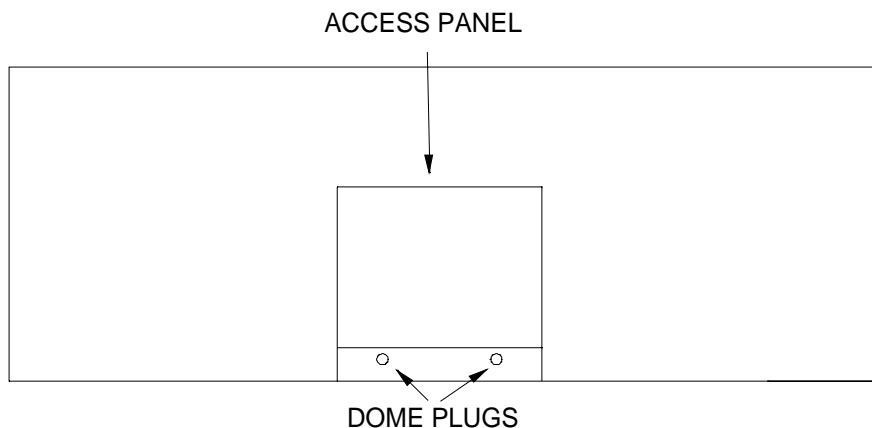

Figure 6 Rear Access Panel

2. Figure 7 shows the view behind the access panel. Feed the power cables through one of the holes in the plate below the access panel.
3. Crimp fork terminals to the power cable wires.

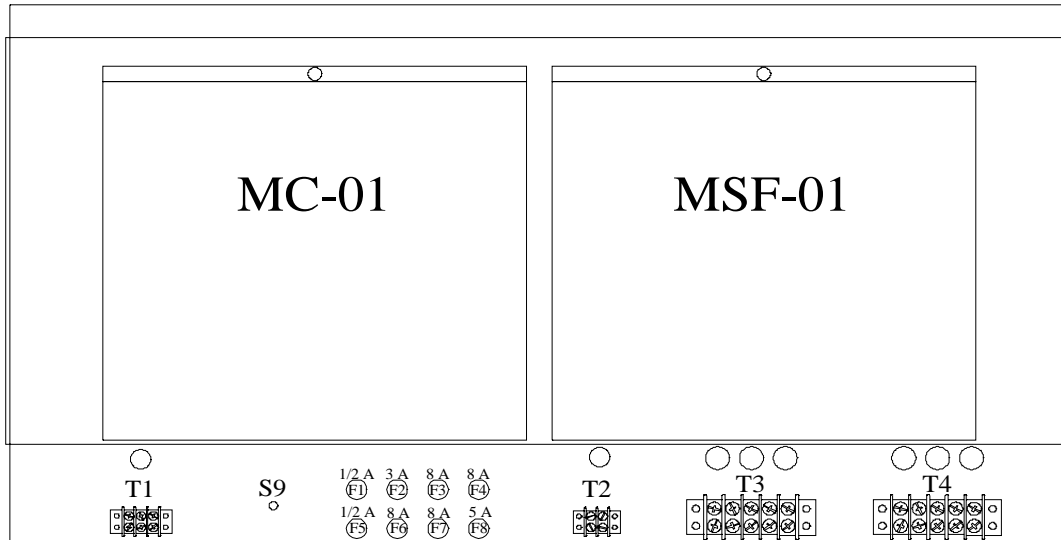

Figure 7 Access Panel Removed

4. If you are going to connect the scoreboard to a 240 VAC supply, connect one AC line wire to position 2, AC neutral wire to position 3, and the other AC line wire to position 4 of terminal strip T4 on the junction chassis according to figure 8.

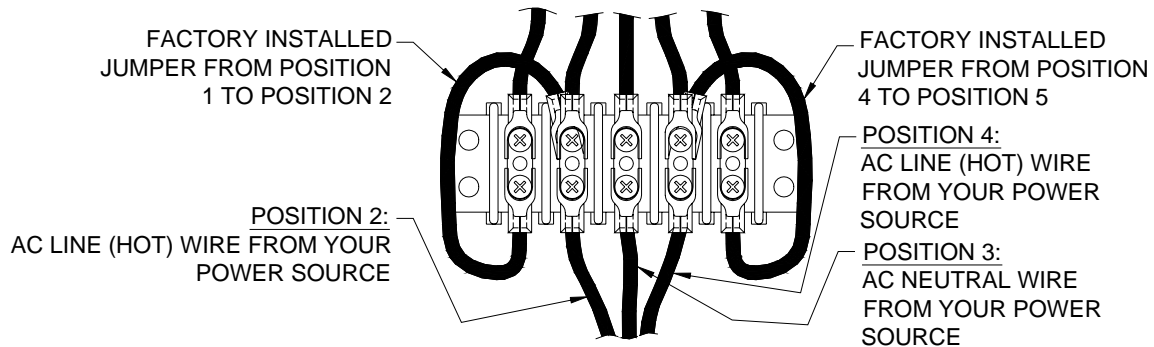

Figure 8 240 VAC Connections

- If you are going to connect the scoreboard to a 120 VAC supply, connect the AC line wire to position 2 and the AC neutral wire to position 3 of terminal strip T4 on the junction chassis. Add a jumper from position 2 to position 4. **This jumper is not provided.** Refer to figure 9.

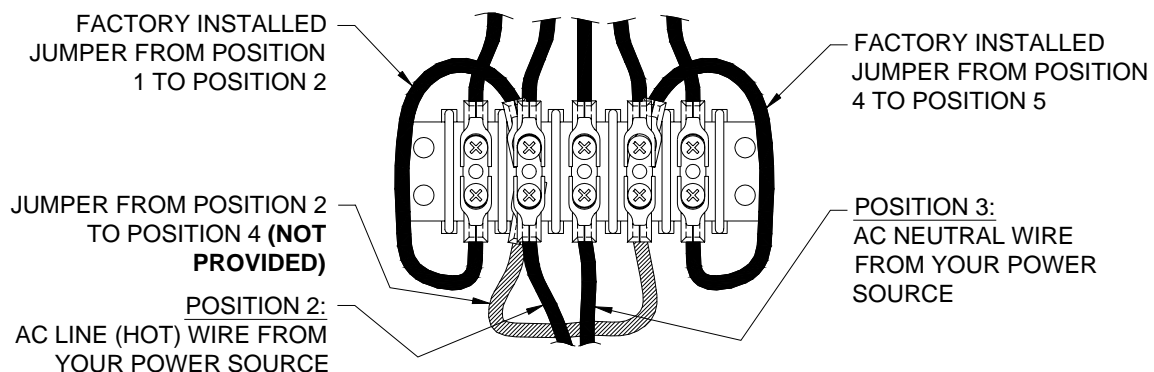

Figure 9 120 VAC Connections

Install a power disconnect that isolates all current carrying conductors on one of the posts below the scoreboard (not the ground conductor). If a secondary switch is installed near the scorekeeper's table, it should also isolate these conductors. Place the power disconnect in the **OFF** position between games to help protect the scoreboard from lightning damage. A power disconnect on the scoreboard post also provides a convenient way of turning the scoreboard off during maintenance or repairs.

Horn Installation

The items provided to install the horn are the horn, the mounting bolt, and the mounting bracket. Items which are not provided but are necessary for proper installation are ¾" flexible conduit, a two ¾" male conduit connectors, a ¾" straight male conduit connector, two wires, two forked crimp terminals, and two butt splice connectors. The electrical requirements for the horn are 0.35 A 120 VAC. The horn is mounted to the top of the scoreboard. A tapped hole is provided to fasten the horn to the scoreboard. The mounting bolt is screwed into the tapped hole at the factory. The following steps describe the assembly and mounting of the horn:

1. Cut a piece of ¾" conduit of sufficient length to reach from the horn mounting point to one of the knockouts below the access panel.
2. Attach the conduit connectors to the ends of the conduit.
3. Cut two pieces of wire of approximately 4 feet longer than the conduit.
4. Push the wires through the conduit.
5. Peel the tape off the horn projector.
6. Remove the plastic bag from inside the horn projector.
7. Remove the four screws that fasten the horn and horn projector to the weatherproof back box.
8. Feed the two wire leads that are attached to the rear side of the horn through one of the threaded holes on the side of the weatherproof back box. Two of the holes will accept a ¾" conduit connector.
9. Plug the other two threaded holes with the plugs from the plastic bag.
10. Splice the horn wire leads to the two wires that run through the conduit with the butt splice connectors.
11. Screw the conduit connector into the threaded hole on the weatherproof back box.
12. Attach the horn and horn projector to the weatherproof back box using the four screws.
13. Fasten the horn assembly to the scoreboard using the mounting bolt from the scoreboard.
14. Crimp forked terminals on the ends of the two wires that protrude out of the other end of the conduit.
15. Pass the wires through one of the knockouts below the access panel.
16. Fasten the conduit connector to the knockout panel and connect the wires to T-2 behind the access panel.

ScoreLink 300

The ScoreLink 300 RF MODEM SYSTEM is designed to eliminate the control cable between the scoreboard and the control console on Electro-Mech Scoreboard MM and MP series scoreboards as well as all LED scoreboards. If you have purchased this accessory, disregard the section of this manual titled **Control Cable Installation**. Refer to the ScoreLink 300 RF MODEM SYSTEM OWNER'S HANDBOOK for installation instructions.

Control Cable Installation

The control cable connects the scoreboard to the control console. Install the control cable in conduit. If the cable is ever damaged, it is easier and less expensive to replace a cable in conduit. A small junction box with a ¼" stereo jack mounted on the face plate is attached to the control cable at the point of operation of the scoreboard. This junction box should be securely mounted in a clean, dry area within ten feet of the rear of the control console. Most customers order the control cable with the junction box attached. Some customers prefer to attach the junction box after the cable is installed. Those customers must solder the control cable to the ¼" stereo jack. Figure 10 shows the control cable wire connection points on the rear of the ¼" stereo jack.

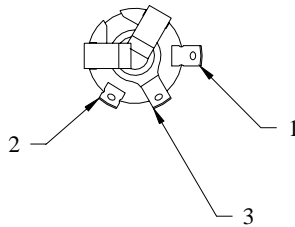

PIN 1 - BLACK WIRE
PIN 2 - RED WIRE
PIN 3 - SHIELD WIRE

Figure 10 ¼" Stereo Jack Wiring Diagram

The following steps describe how to connect the control cable to the scoreboard:

1. At the rear of the scoreboard feed the control cable one of the holes in the plate below the access panel.
2. Crimp fork terminals to the control cable wires and the shield.
3. Connect the control cable to T1 terminal block on the junction chassis according to figure 11.

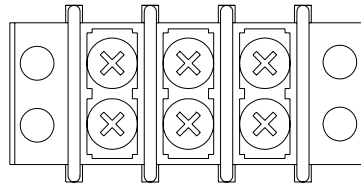

BLACK RED SHIELD
WIRE WIRE WIRE

Figure 11 Control Cable Wiring Diagram

4. Reinstall the access panel.

Control Console Connections

The 10 ft. extension cable has two molded ¼” stereo plugs attached to it. It is used to connect the control console to the junction box. The following steps describe how to connect the control console:

1. Plug one end of the extension cable into ¼” stereo jack on the junction box or the ScoreLink 300 Transmitter, if purchased.
2. Plug the other end into the ¼” stereo jack mounted on the control console back plate.
3. Plug the control console power cord into a grounded NEMA 5-15R 120 VAC receptacle.

Control Console Safety Warning

This product is equipped with a 3-wire grounding type plug, a plug having a third (grounding) pin. This plug will only fit into a grounding-type power outlet. This is a safety feature. If you are unable to insert the plug into the outlet, contact a qualified electrician to replace your obsolete outlet. Do not defeat the purpose of the grounding-type plug.

SCOREBOARD OPERATION

SCOREBOARD STARTUP

1. Place the power disconnect for the scoreboard in the **ON** position.
2. Plug one end of the extension cable into ¼" stereo jack on the junction box or the ScoreLink 300 Transmitter, if purchased.
3. Plug the other end into the ¼" stereo jack mounted on the control console back plate.
4. Plug the control console power cord into a grounded NEMA 5-15R 120 VAC receptacle.
5. If a ScoreLink 300 RF MODEM SYSTEM is installed with this scoreboard, plug the wall mount DC power supply into a grounded NEMA 5-15R 120 VAC receptacle and the male plug on the end of the attached cable into the Power jack on the Transmitter.

GAME TIME OPERATION

This scoreboard is operated with a 37-key control console. Figure 12 shows the keypad layout on the control console.

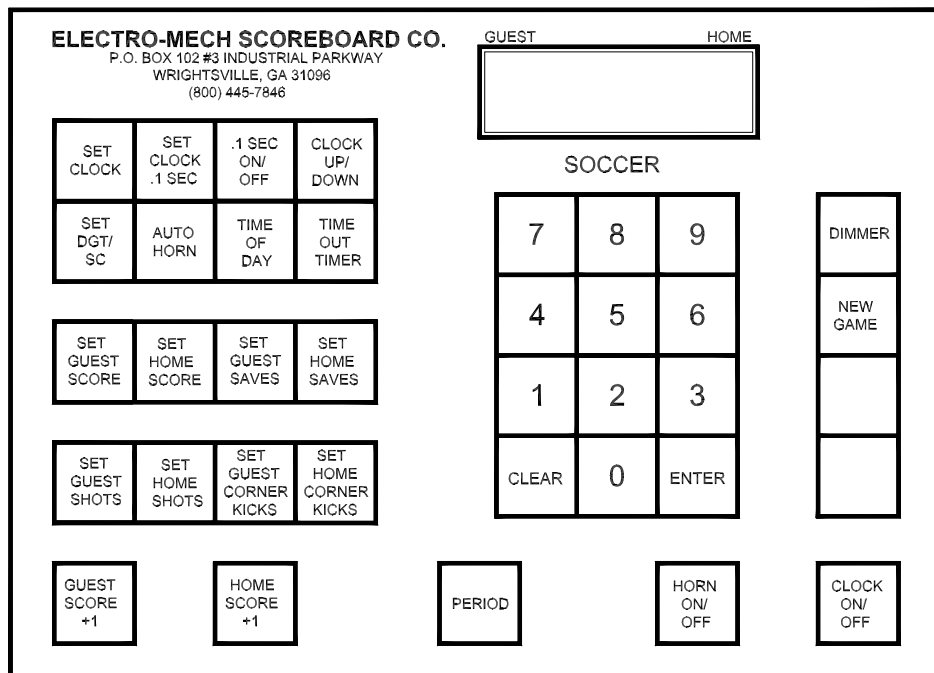

Figure 12 Keypad Layout

Immediately after the control console power cord is plugged into a 120 VAC source, the console LCD display will read:

ELECTRO-MECH VER
SCOREBOARD SK2

After a few seconds the display will read:

```
00  D15:00 0 00
```

The scoreboard will display:

CLOCK – 15:00
 GUEST SCORE – 0
 HOME SCORE – 0

The control console LCD display shows the same information as the scoreboard. Note: In some functions a 0 will be blanked on the scoreboard, but not on the console. Figure 13 explains the LCD display layout.

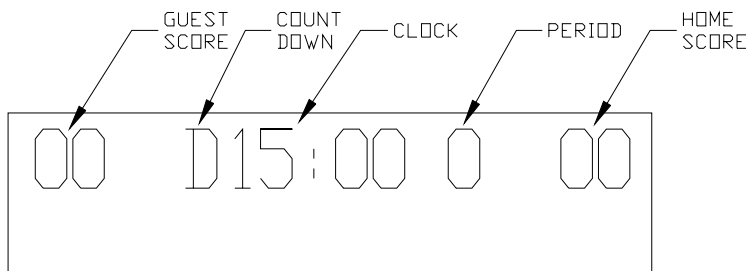

Figure 13 Control Console LCD Display

Control Console Key Functions

1. **SET CLOCK** – This key sets the time displayed on the scoreboard clock. Press [SET CLOCK]. The console LCD display will read:

```
00  D15:00 0 00
SET CLK <00:00>
```

Press the keypad numbers for the time, [ENTER]. Example: Press [SET CLOCK], [6], [0], [0], [0], [ENTER] on the control console. 60:00 will be displayed on the clock section of the scoreboard.

2. **SET CLOCK .1 SEC** – This key is used to set the scoreboard clock to a time less than one minute when tenth of a second accuracy is required. Press [SET CLOCK .1 SEC]. The console LCD display will read:

```
00  D15:00 0 00
SET SEC <00.0>
```

Press the keypad numbers for the time, [ENTER]. Example: Press [SET CLOCK .1 SEC], [5], [3], [8], [ENTER] on the control console. 53.8 will be displayed on the clock section of the scoreboard.

3. **.1 SEC ON/OFF** – This key is used to enable or disable the display of tenths of seconds on the scoreboard. The use of this key has a visible effect on the scoreboard only if the game clock is less than one minute. This mode is enabled when the control console is turned on. If it is disabled, the LCD display on the control console will still show 1/10th second timing, but the scoreboard will not display it. To turn this function off, press [.1 SEC ON/OFF]. The console LCD display will read:

```
CLOCK  ON  <1>
.1 SEC  OFF <0>
```

Press [0], [ENTER] on the control console.

4. **CLOCK UP/DOWN** – The clock can be set up to either count up or count down. The control console is set to the clock down mode when it is turned on. To make the clock count up, press [CLOCK UP / DOWN]. The console LCD display will read:

```
GAME    UP  <1>
CLOCK   DOWN <0>
```

Press [1], [ENTER] on the control console. The letter D in front of the game time on the console LCD will be replaced with the letter U to indicate that the clock is in the count up mode. To reset the clock to count down mode, press [CLOCK UP / DOWN], [0], [ENTER] on the control console.

5. **SET DGT/SC** – The console is programmed with two delay of game timers. The delay of game timers should be set prior to the start of a game. Delay of Game Timer 1 is preset to 30 seconds. Delay of Game Timer 2 is preset to 5 seconds. To change either one of these times, press [SET DGT/SC]. The console LCD display will read:

```
00  D15:00 0 00
DELAY TIME1 <30>
```

Press the keypad numbers to set Delay of Game Timer 1, [ENTER]. The LCD display will then read:

```
00  D15:00 0 00
DELAY TIME2 <05>
```

Press the keypad numbers to set Delay of Game Timer 2, [ENTER].

6. **AUTO HORN** – This key allows the operator to control the end of period horn and the time out horn. The horn sounds for two seconds when the clock reaches 0:00 at the end of the period. The end of period horn can be disabled by pressing [AUTO HORN]. The console LCD display will read:

```
GAME PRESS<1>ON
HORN PRESS<0>OFF
```

Press [0], [ENTER] to disable the horn. The console LCD display will then read:

```
T-0 PRESS<1>ON
HORN PRESS<0>OFF
```

The time out horn is normally disabled. To enable the horn to sound at the end of the time out, press [1], [ENTER] on the control console.

7. **TIME OF DAY** – The time of day can be displayed on the clock section of the scoreboard. **THE GAME CLOCK WILL BE INOPERABLE UNTIL THE TIME OF DAY FUNCTION IS TURNED OFF.** To turn the time of day clock on, press [TIME OF DAY]. The console LCD display will read:

```
TIME OF ON <1>
DAY CLOCK OFF<0>
```

Press [1], [ENTER] on the control console. The console LCD display will then read:

```
00 C12:00 0 00
SET CLK <12:00>
```

Press the keypad numbers for the time, [ENTER]. The letter C will be displayed on the console LCD display to the left of the time to indicate that the time of day function is active. The scoreboard will display the time of day.

8. **TIME OUT TIMER** – To set the Time Out Timer, press [TIME OUT TIMER]. The console LCD display will read:

```
00 D15:00 0 00
SET T-0 <1:00>
```

Press the keypad numbers for the time, [ENTER]. After the ENTER key is pressed, the letter T is displayed to the left of the time on the LCD display and the Time Out Timer immediately begins to count down to 0. The scoreboard will not display the Time Out time. To exit the Time Out Timer function before 0, press [TIME OUT TIMER], [ENTER].

9. **SET GUEST SCORE** – To set the visitor score, press [SET GUEST SCORE]. The console LCD display will read:

```
00  D15: 00 0  00
GUEST SCORE <00>
```

Press the keypad numbers for the score, [ENTER]. **EXAMPLE:** To set the visitor score to 53, press [SET GUEST SCORE], [5], [3], [ENTER].

10. **SET HOME SCORE** – To set the home score, press [SET HOME SCORE]. The console LCD display will read:

```
00  D15: 00 0  00
HOME SCORE  <00>
```

Press the keypad numbers for the score, [ENTER]. **EXAMPLE:** To set the home score to 75, press [SET HOME SCORE], [7], [5], [ENTER].

11. **GUEST SCORE +1** – This key is used to increment the visitor score by 1.
 12. **HOME SCORE +1** – This key is used to increment the home score by 1.
 13. **PERIOD** – This key is used to increment the period by 1.
 14. **HORN ON/OFF** – This key is used to toggle the horn on and off.
 15. **CLOCK ON/OFF** – This key is used to start and stop the clock.
 16. **NEW GAME** – This key is used to reset all the scoreboard functions to their default settings. To reset the scoreboard, press [NEW GAME]. The console LCD display will read:

```
RESET   YES<1>
SCOREBOARD NO<0>
```

Press [1], [ENTER] on the control console. The scoreboard will reset its functions.

17. **DIMMER** – This key is used to dim all the scoreboard lamps. To dim the scoreboard lamps, press [DIMMER]. The console LCD display will read:

```
DIMMER   YES<1>
ON       NO<0>
```

Press [1], [ENTER] on the control console. The scoreboard will dim its lamps.

The SET GUEST SHOTS, SET HOME SHOTS, SET GUEST SAVES, SET HOME SAVES, SET GUEST CORNER KICKS, and SET HOME CORNER KICKS keys are not used with the MP-363 scoreboard.

Hand Held Clock Control Unit Operation

The hand held clock control unit has an attached cable that is plugged into a jack on the control console back plate labeled **Clock Hand held**. It has one button that is used to toggle the clock on and off.

You should reset the scoreboard each time that it is turned on. Test out all the functions to ensure that the scoreboard is operating properly.

SCOREBOARD SHUTDOWN

1. Place the power disconnect for the scoreboard in the **OFF** position.
2. Unplug the control console power cord.
3. Unplug the extension cable.
4. If a ScoreLink 300 RF MODEM SYSTEM is installed with this scoreboard, unplug the Transmitter's wall mount power supply.
5. Store the control console and ScoreLink 300 Transmitter in a dry location. These units are not waterproof.

Proper scoreboard shutdown will help protect the scoreboard and control console from power surges and lightning strikes.

SERVICING THE SCOREBOARD

While your scoreboard was designed for years of trouble-free operation, some problems may occasionally occur. Electro-Mech Scoreboard Company offers onsite service in some areas. In other areas, we can help you contact an independent service technician. In areas in which service is not available from Electro-Mech Scoreboard Company, we will make every effort to answer your questions. Our trained personnel at Electro-Mech Scoreboard Company are ready to answer your questions from Monday to Friday during the hours of 8 AM to 5 PM Eastern Standard Time. Be sure to know your scoreboard model number when calling. Scoreboard replacement parts are always available. Damaged parts can usually be repaired at a significant cost savings. Our convenient toll free number is listed at the bottom of every page in this manual.

If the scoreboard turns on lamps, but does not operate normally, make note of which functions are affected. If some lamps either never turn on or always stay on, make note of their specific locations on the scoreboard. Refer to the LAMP REPLACEMENT section of this manual before changing lamps.

COMPONENT REPLACEMENT

Lamp Replacement

Remove the protective mask covering each lamp bank to access the lamps. **To avoid damage to the plug in module, always turn off the power to the scoreboard when changing lamps.** We recommend using a felt pen or tape to mark lamps that will not light. The scoreboard uses 15 watt 120 VAC frosted medium based appliance lamps (also known as 15A15IF lamps). **Never replace these with higher wattage lamps.**

All other components are located behind the rear access panels. Figure 14 shows the components behind the access panel.

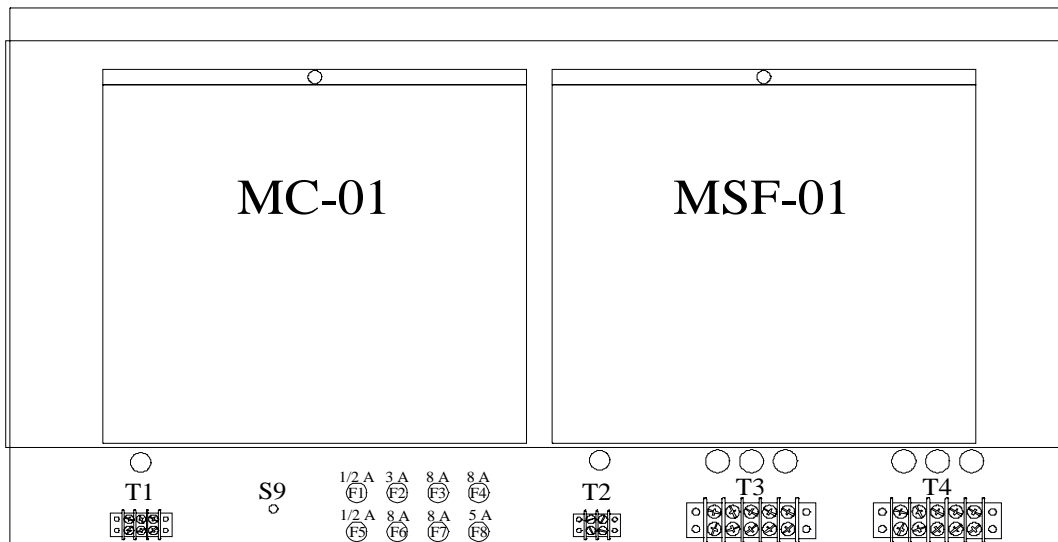

Figure 14 Access Panel Components

The plug in module MSF-01 operates VISITOR SCORE and HOME SCORE. The plug in module MC-01 operates the CLOCK, PERIOD, and the horn.

Plug In Module Replacement

Each module has four bottom plugs that mate with sockets on the junction chassis. A screw located at the top of the module holds it against the junction chassis. Remove the screw and pull the module upward to unseat the module. **To avoid damage to the plug in module, always turn off the power to the scoreboard when removing or replacing it.**

FUSES

FUSE	RATING	FUNCTION	BUSSMANN PART #
F1	1/2 A 250 V	CONTROL LINE	AGC-1/2
F2	3 A 250 V	HORN	AGC-3
F3	8 A 250 V	MINUTES	AGC-8
F4	8 A 250 V	SECONDS	AGC-8
F5	1/2 A 250 V	CONTROL LINE	AGC-1/2
F6	8 A 250 V	HOME SCORE	AGC-8
F7	8 A 250 V	GUEST SCORE	AGC-8
F8	5 A 250 V	PERIOD	AGC-5

Note: Other manufacturer's fuses may be substituted for the Bussmann fuses.

ELECTRO-MECH SCOREBOARD CO. FIVE YEAR LIMITED WARRANTY

THE ELECTRICAL COMPONENTS OF ALL ELECTRO-MECH SCOREBOARDS ARE GUARANTEED FOR A PERIOD OF FIVE (5) YEARS FROM THE DATE OF INVOICE AGAINST DEFECTS IN WORKMANSHIP OR MATERIAL AND WILL BE REPLACED OR REPAIRED WITHOUT COST TO THE OWNER PROVIDED THE EQUIPMENT OR PARTS ARE RETURNED POSTAGE-PAID TO THE FACTORY IN WRIGHTSVILLE, GA. SHIPPING BACK TO THE OWNER WILL BE VIA UPS GROUND SERVICE EXCEPT WHEN AIR OR SPECIAL METHOD OF RETURN IS SPECIFIED BY THE OWNER, IN WHICH CASE SHIPPING WILL BE FREIGHT COLLECT.

EXCLUDED FROM THIS WARRANTY ARE LAMPS, FUSES AND SOCKETS.

THIS WARRANTY DOES NOT INCLUDE LABOR CHARGES INCURRED IN THE REMOVAL OF COMPONENT PARTS, SERVICE CALLS, OR DAMAGES RESULTING FROM IMPROPER INSTALLATION, IMPROPER OPERATION, OR PROBLEMS CAUSED BY ANY REPAIR, ALTERATION OR MODIFICATION OF THE SCOREBOARD NOT PERFORMED BY ELECTRO-MECH.

EQUIPMENT WHICH IS SUBJECTED TO ACCIDENT, NEGLIGENCE, ABUSE, MISUSE OR OTHER NATURAL DISASTERS, INCLUDING BUT NOT LIMITED TO FIRE, WIND, LIGHTNING, OR FLOOD, IS NOT COVERED BY THIS GUARANTEE.