

---

## ELECTRO-MECH SCOREBOARD CO.

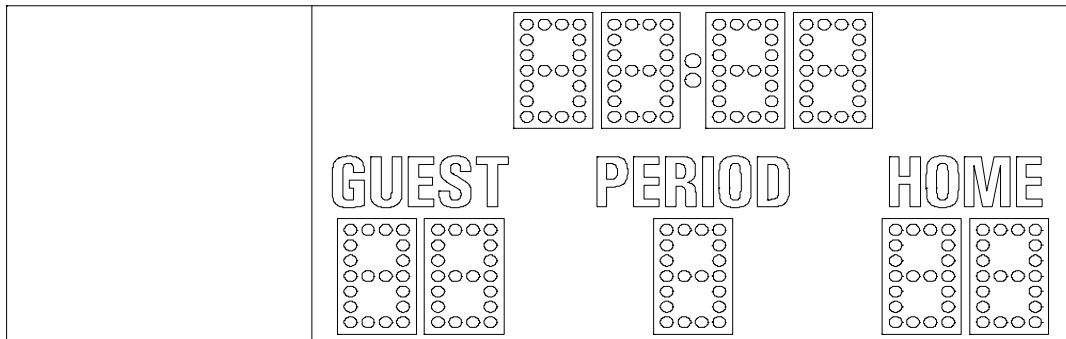

## MM-368 SOCCER SCOREBOARD

## OWNER'S HANDBOOK

Thank you for choosing an Electro-Mech Scoreboard for your athletic complex. We are confident that your new scoreboard will give many years of reliable service.

---

## TABLE OF CONTENTS

<b>MM-368 SCOREBOARD SPECIFICATIONS .....</b>	<b>3</b>
<b>SCOREBOARD INSTALLATION.....</b>	<b>4</b>
POSITIONING THE POSTS.....	4
MOUNTING HARDWARE.....	6
MOUNTING THE OPTIONAL TOP SPONSOR PANEL .....	7
MOUNTING THE SCOREBOARD .....	8
ELECTRICAL CONNECTIONS.....	9
<b>Ground Connection .....</b>	<b>9</b>
<b>Connecting The Scoreboard To Your Power Source .....</b>	<b>9</b>
<b>Installing The Horn .....</b>	<b>12</b>
<b>ScoreLink 300.....</b>	<b>13</b>
<b>Installing The Control Cable .....</b>	<b>13</b>
<b>Connecting The Control Console .....</b>	<b>14</b>
<b>SCOREBOARD OPERATION.....</b>	<b>15</b>
HAND HELD CLOCK CONTROL UNIT OPERATION .....	16
<b>SERVICING THE SCOREBOARD.....</b>	<b>17</b>
PLUG IN MODULE REPLACEMENT .....	18
LAMP REPLACEMENT .....	18
<b>WARRANTY.....</b>	<b>19</b>

## MM-368 SCOREBOARD SPECIFICATIONS

**GENERAL:** This ETL listed scoreboard includes the scoreboard cabinet, side sponsor panel, horn, mounting hardware, control console, control cable (sold separately), 10 ft. extension cable, and junction box.

**DIMENSIONS:** 14' L x 5' H x 6" D

**WEIGHT:** 270 lbs

**SCOREBOARD CONSTRUCTION:** The outer frame is made from extruded aluminum. Internal structural parts may be extruded or formed from aluminum sheet. The face and back are made from aluminum sheet. The face is finished with enamel paint. Black is the standard face color. White is the standard color for the sponsor panel and captions. Mounting hardware is included.

**DISPLAY:** The MM-368 scoreboard displays HOME and GUEST scores to 99, TIME to 60 minutes, and PERIOD to 9.

**LAMP BANKS:** A 4 x 7 matrix of lamps forms each 18" digit. The scoreboard uses 15 watt 120 VAC frosted medium based appliance lamps (also known as 15A15IF lamps). Recessed aluminum reflectors provide a crisp separation between each lamp. Expanded metal screens protect the lamps.

**POWER REQUIREMENTS: Scoreboard** - 120 VAC, 22.5 A, 60 Hz, 2700 watts maximum, (30 A service recommended). The scoreboard may be connected to either 120 VAC or 240 VAC single phase. **Control Console** - 120 VAC, 0.5 A, 60 Hz

**SCOREBOARD ELECTRONICS:** 100% solid state fully enclosed within 2 plug in modules.

**CONTROL CONSOLE:** The microprocessor control console is constructed of a rugged plastic housing with a metal back plate. It features a 15 key sealed membrane keypad, an attached 6 foot power cord, and a lithium cell battery backup to retain game information.

**CONTROL CABLE:** The cable has two 22 AWG stranded copper conductors with semi-rigid PVC insulation. It also has a braided shield and a foil shield. The polyethylene jacket is rated at 300 volts. The cable is direct burial rated and measures approximately 1/4" in diameter. One length is required to run from the scoreboard to the point of operation (conduit installation recommended).

**JUNCTION BOX AND EXTENSION CABLE:** A 4 1/4" x 2 1/4" x 2" junction box with a stereo jack mounted on the face is attached to the control cable at the point of operation. A ten foot extension cable connects the control console to the junction box.

**WARRANTY:** Five year limited warranty.

## SCOREBOARD INSTALLATION

Installation of the MM-368 Scoreboard consists of positioning the posts, mounting the scoreboard cabinet on the posts, and making the proper electrical connections.

Items not provided by Electro-Mech Scoreboard Company which are necessary for installation:

- Two posts
- Power cable to connect the scoreboard to your power source
- Grounding hardware
- A grounded NEMA 5-15R 120 VAC receptacle for the control console.

Items not provided which are recommended by Electro-Mech Scoreboard Company for installation:

- A weatherproof power disconnect at the scoreboard
- A weatherproof NEMA 5-15R 120 VAC convenience receptacle at the scoreboard

While Electro-Mech Scoreboard Company does not perform installations, we will make every effort to answer your installation questions. Installation should be performed by qualified personnel. Consult national and local codes before installation.

## POSITIONING THE POSTS

The scoreboard is designed to be mounted on two posts. We suggest that the front of the scoreboard should be angled away from the afternoon sun, if possible. Typically installers will use steel pipes or I-beams. The mounting hardware will accommodate posts up to 4.5 inches outer diameter. We recommend that the posts are sunk in reinforced concrete footings. Figure 1 shows the spacing of the posts for a MM-368. It suggests one possible installation for a MM-368 in silty sand soil. **No dimensional data in this manual is intended to be specifications except the size of the scoreboard cabinet and the distance between the posts.** The specifications for the posts and concrete footings are dependent upon the expected local wind and soil conditions, the height of the scoreboard from the ground, and the local building codes. Electro-Mech Scoreboard Company assumes no responsibility for the installation of scoreboards by others.

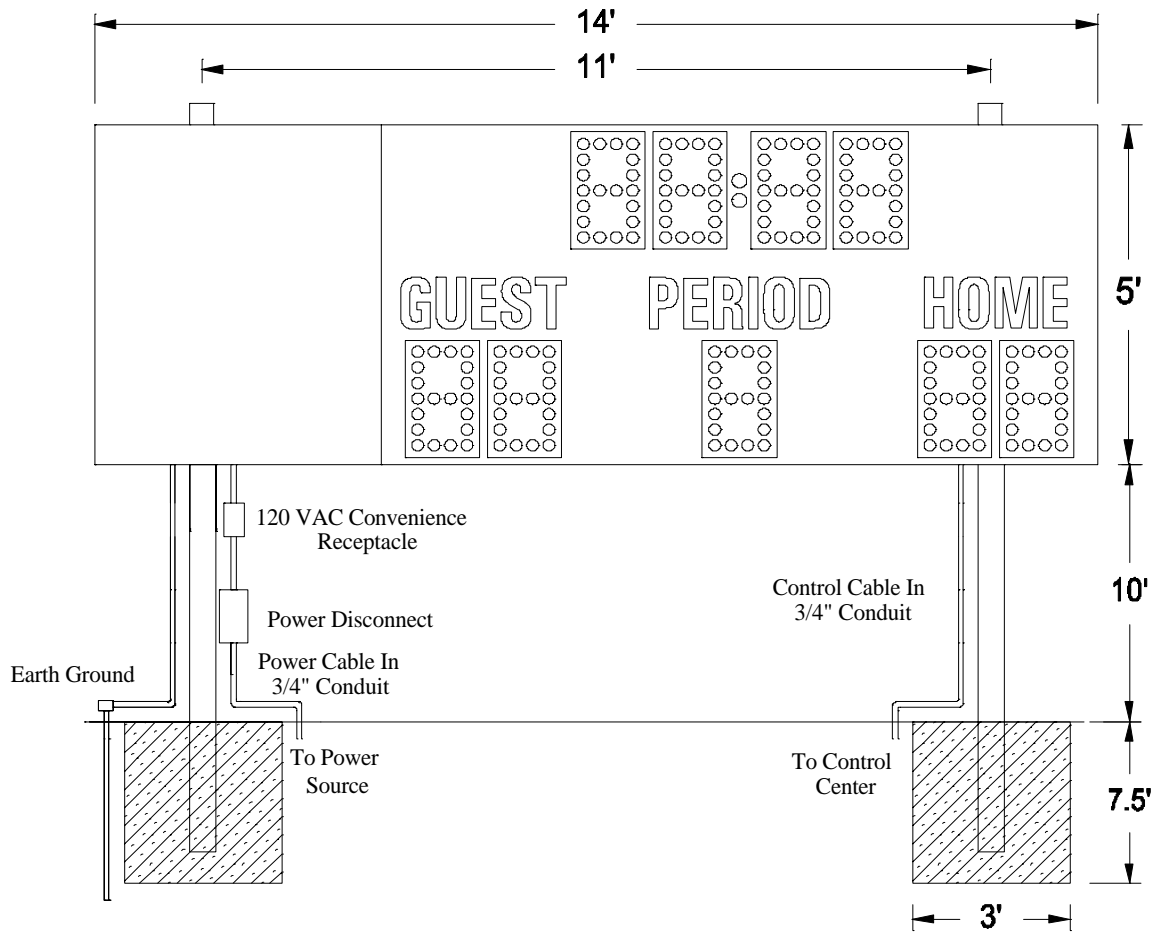

**Figure 1 MM-368 Post Spacing**

Figure 2 shows the spacing of the posts for a MM-368 with an optional top sponsor panel.

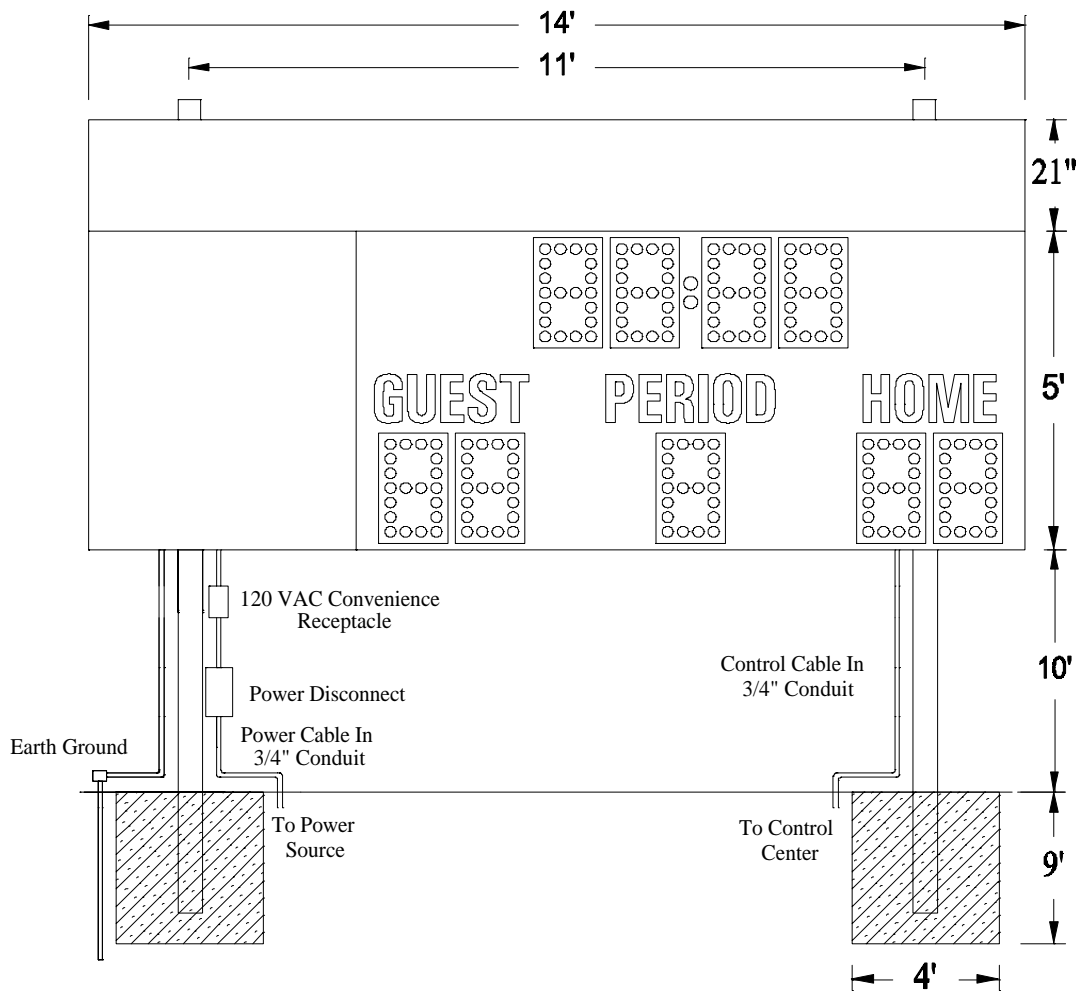

**Figure 2 MM-368 with Optional Top Sponsor Panel Post Spacing**

## MOUNTING HARDWARE

Four sets of mounting hardware are provided to attach the scoreboard to the posts. Additional hardware sets are provided to attach the optional sponsor panels, if ordered. A mounting hardware set consists of a steel angle bracket, two threaded rods, two washers, and two nuts. Figure 3 shows an overhead cross section view and a side cross section view of the scoreboard attached to a post at a mounting point using the hardware. A steel bracket is riveted to the scoreboard's aluminum extrusion frame. The bracket has two tapped holes. The threaded rods screw into these tapped holes. The washers and nuts are used to clamp the steel angle bracket against the steel post and hold the scoreboard in place.

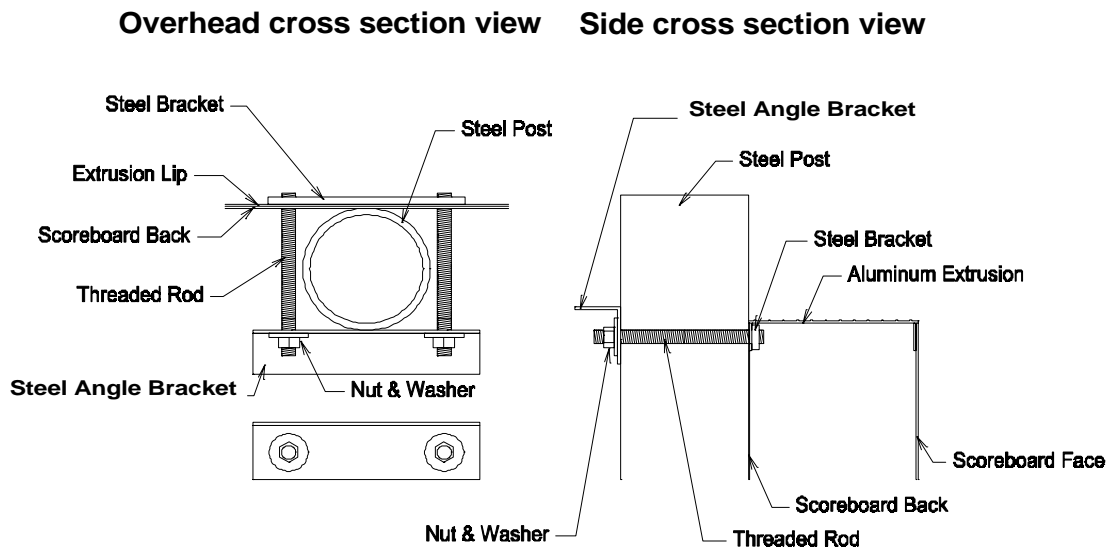

**Figure 3 Standard Mounting Method**

## **MOUNTING THE OPTIONAL TOP SPONSOR PANEL**

The following steps describe how to mount the top sponsor panel on the posts:

1. Place the top sponsor panel against the posts on the ground. Make sure the mounting points are aligned with the posts.
2. Screw the threaded rods into the tapped holes in the top sponsor panel.
3. Place a steel angle bracket over the threaded rods at a mounting point.
4. Place a washer over each threaded rod.
5. Screw the nuts onto the threaded rods so that the bracket is **loosely** held in place.
6. Repeat steps 4 -6 at the other mounting points.
7. Raise the top sponsor panel into place and tighten the nuts to clamp it in place on the posts.

## MOUNTING THE SCOREBOARD

The scoreboard is attached to the posts at four points. Figure 4 shows the location of the mounting points on the rear of the scoreboard.

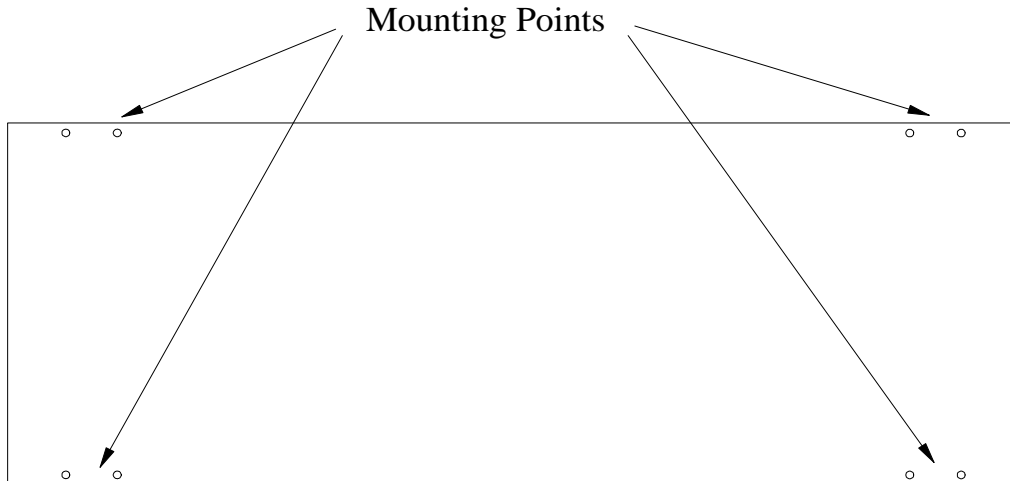

**Figure 4 Mounting Points**

The following steps describe how to mount the scoreboard on the posts:

1. Place the scoreboard cabinet against the posts on the ground. Make sure the mounting points are aligned with the posts.
2. Screw the threaded rods into the tapped holes in the scoreboard.
3. Place a steel angle bracket over the threaded rods at a mounting point.
4. Place a washer over each threaded rod.
5. Screw the nuts onto the threaded rods so that the bracket is **loosely** held in place.
6. Repeat steps 4 -6 at the other mounting points.
7. Raise the scoreboard into place and tighten the nuts to clamp the scoreboard in place on the posts.



## ELECTRICAL CONNECTIONS

We recommend a qualified electrician perform the needed electrical connections to ensure proper operation of your scoreboard. These connections include grounding the scoreboard, connecting the scoreboard to a power source, installing the control cable, and connecting the control console.

### Ground Connection

The National Electrical Code **requires** a scoreboard (electric sign) to be grounded. Grounding the scoreboard helps the scoreboard electronics operate properly and helps minimize damage if it is struck by lightning. Metal posts do **not** provide an adequate ground path when they are placed in concrete. One method of grounding is to connect the scoreboard to one or more grounding rods which are driven into the ground near the scoreboard via a large gauge copper wire. The self tapping sheet metal screws on the back of the scoreboard cabinet provide a convenient connection point.

### Connecting The Scoreboard To Your Power Source

The scoreboard may be connected to 240 VAC single phase or 120 VAC service at the scoreboard. **Maximum power consumption of Model MM-368: 2700 Watts.** Make sure that the power cables are rated for this electrical load. Electro-Mech Scoreboard Company recommends that your power cable is installed in conduit. **Avoid** running your power cables in close proximity to your control cable. The following steps describe how to connect the scoreboard to your power source:

1. Remove the hex head screws which hold the rear access panel in place (Figure 5).

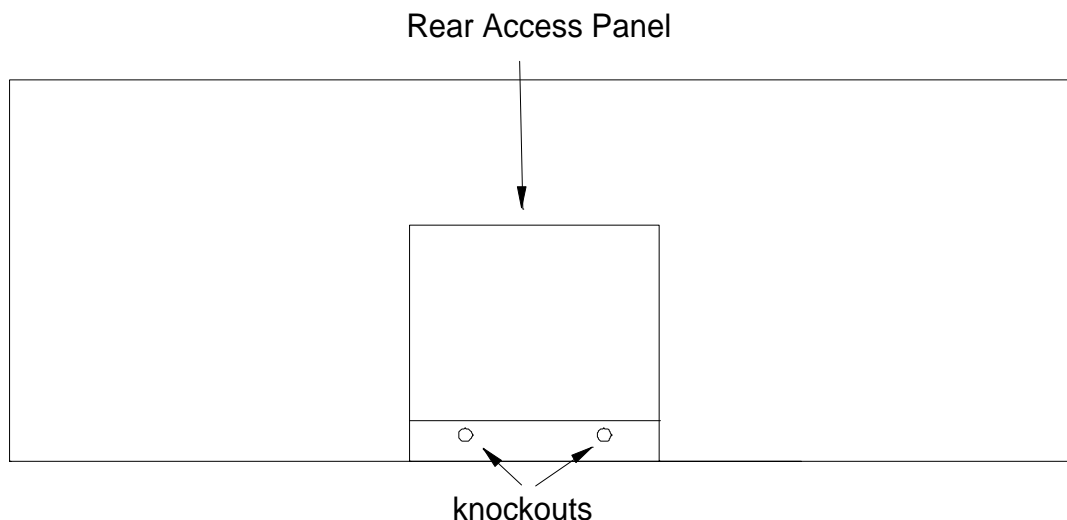

**Figure 5 Rear Access Panel**

Figure 6 shows the view behind the access panel.

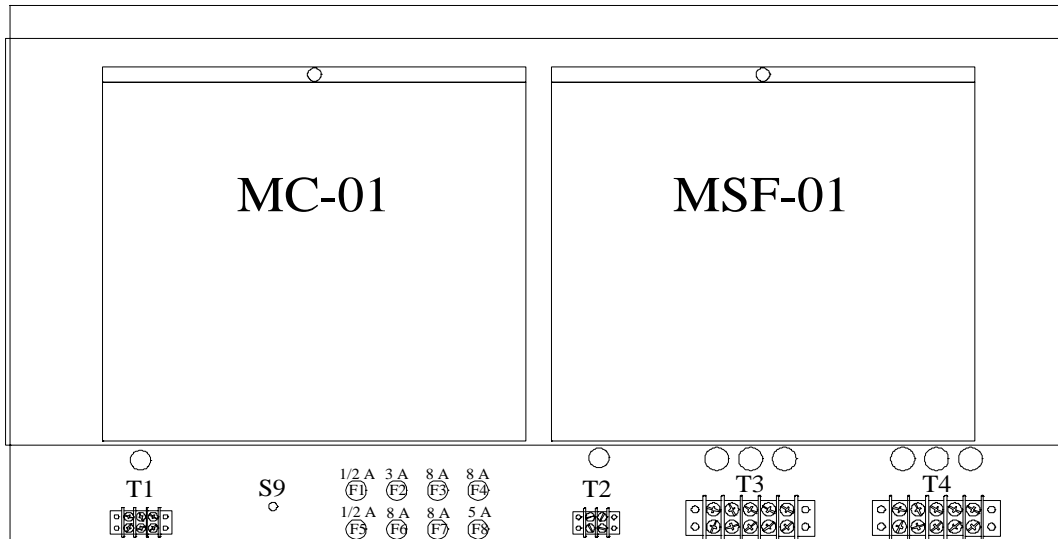

**Figure 6 Access Panel Removed**

2. Punch out the knockouts for the power and control cables.
3. Feed the power cables through a knockout.
4. If you are going to connect the scoreboard to a 240 VAC supply, connect one AC line wire to position 2, AC neutral wire to position 3, and the other AC line wire to position 4 of terminal strip T4 on the junction chassis according to figure 7.

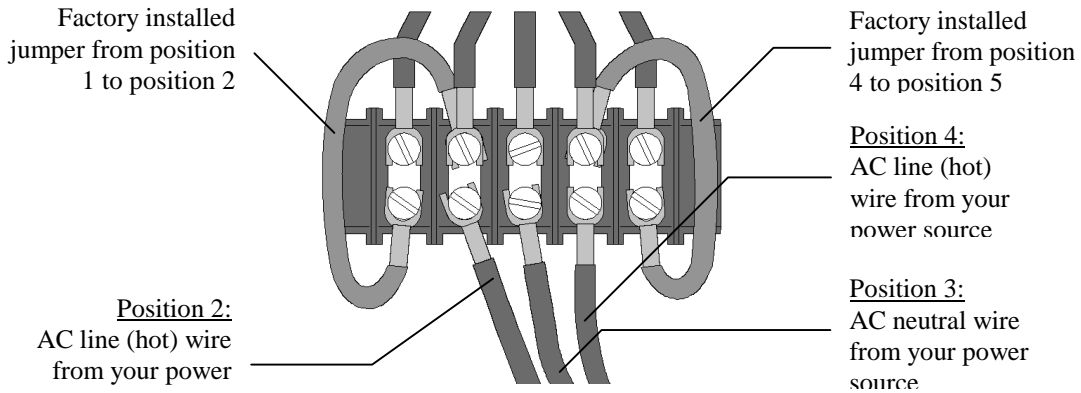

**Figure 7 240 VAC Connections**

5. If you are going to connect the scoreboard to a 120 VAC supply, connect the AC line wire to position 2 and the AC neutral wire to position 3 of terminal strip T3 on the junction chassis. Add a jumper from position 2 to position 4. **This jumper is not provided.** Refer to figure 8.

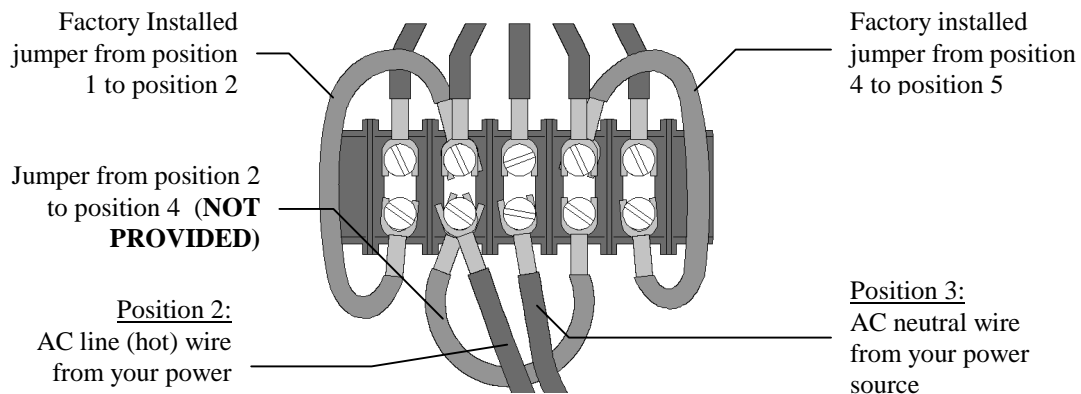

**Figure 8 120 VAC Connections**

Electro-Mech Scoreboard Company suggests that you install a power cut-off switch and a NEMA 5-15R receptacle in a weatherproof box on the scoreboard post below the scoreboard. The cut-off switch provides a convenient way of turning the scoreboard off during maintenance or repairs. The NEMA 5-15R receptacle will allow a technician to easily plug in the control console and operate the scoreboard via the test jack S-9 (a valuable trouble-shooting aid).

### **Installing The Horn**

The items provided to install the horn are the horn, the mounting bolt, and the mounting bracket. Items which are not provided but are necessary for proper installation are  $\frac{3}{4}$ " flexible conduit, a two  $\frac{3}{4}$ " male conduit connectors, a  $\frac{3}{4}$ " straight male conduit connector, two wires, two forked crimp terminals, and two butt splice connectors. The electrical requirements for the horn are 0.35 A 120 VAC. The horn is mounted to the top of the scoreboard. A tapped hole is provided to fasten the horn to the scoreboard. The mounting bolt is screwed into the tapped hole at the factory. The following steps describe the assembly and mounting of the horn:

1. Cut a piece of  $\frac{3}{4}$ " conduit of sufficient length to reach from the horn mounting point to one of the knockouts below the access panel.
2. Attach the conduit connectors to the ends of the conduit.
3. Cut two pieces of wire of approximately 4 feet longer than the conduit.
4. Push the wires through the conduit.
5. Peel the tape off the horn projector.
6. Remove the plastic bag from inside the horn projector.
7. Remove the four screws that fasten the horn and horn projector to the weatherproof back box.
8. Feed the two wire leads that are attached to the rear side of the horn through one of the threaded holes on the side of the weatherproof back box. Two of the holes will accept a  $\frac{3}{4}$ " conduit connector.
9. Plug the other two threaded holes with the plugs from the plastic bag.
10. Splice the horn wire leads to the two wires that run through the conduit with the butt splice connectors.
11. Screw the conduit connector into the threaded hole on the weatherproof back box.
12. Attach the horn and horn projector to the weatherproof back box using the four screws.
13. Fasten the horn assembly to the scoreboard using the mounting bolt from the scoreboard.
14. Crimp forked terminals on the ends of the two wires that protrude out of the other end of the conduit.
15. Pass the wires through one of the knockouts below the access panel.
16. Fasten the conduit connector to the knockout panel and connect the wires to T-2 behind the access panel.

### ScoreLink 300

The SCORELINK 300 RF MODEM SET is intended to eliminate the control cable between the scoreboard and the control console on Electro-Mech Scoreboard MM and MP series scoreboards. If you have purchased this option, disregard the next section of this manual. Refer to the SCORELINK 300 RF MODEM SET OWNER'S HANDBOOK for installation instructions.

### Installing The Control Cable

The control cable connects the scoreboard to the control console. While the control cable is direct burial rated, Electro-Mech Scoreboard Company recommends that it is installed in conduit to protect it from being cut. A small junction box with a stereo jack mounted on the face plate is attached to the control cable at the point of operation of the scoreboard. This junction box should be securely mounted in a clean, dry area within ten feet of the rear of the control console. Most customers order the control cable with the junction box attached. Some customers prefer to attach the junction box after the cable is installed. Those customers must match their stereo jack to one of the stereo jacks in figure 9 in order to make the proper connections. These connections should be soldered.

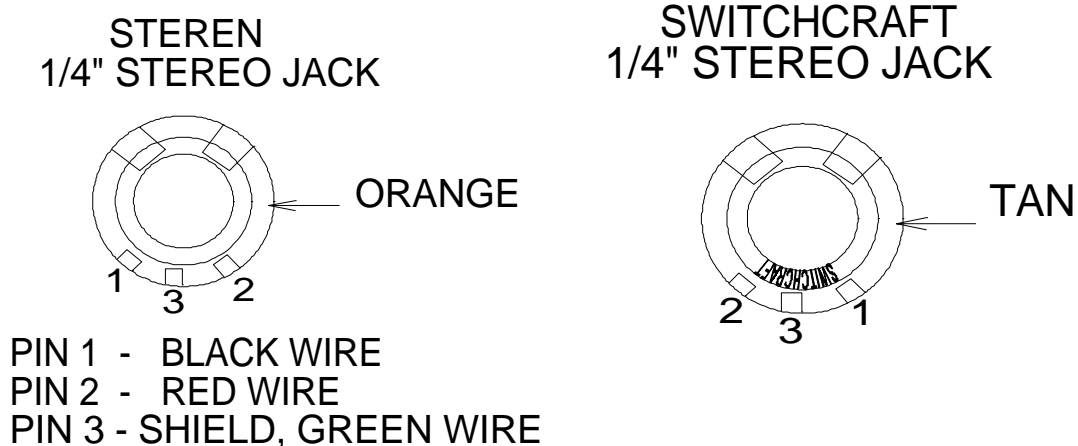

**Figure 9 STEREO JACK WIRING DIAGRAM**

The following steps describe how to connect the control cable to the scoreboard:

1. At the rear of the scoreboard feed the control cable through one of the knockouts below the access panel.
2. Crimp fork terminals to the control cable wires and the shield.
3. Connect the control cable to terminal strip T1 (located to the left of the test jack S9) according to the diagram in figure 10.

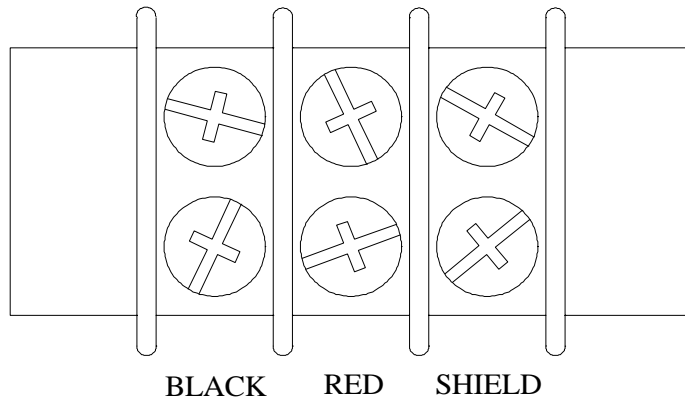

**Figure 10 T1 WIRING DIAGRAM**

### **Connecting The Control Console**

The control console is normally connected to the junction box via the 10 ft. extension cable. This extra length of cable allows the scoreboard operator some mobility and the ability to store the control console after the game. The extension cable has two molded stereo plugs attached to it. One end of the extension cable is plugged into the junction box stereo jack and the other end is plugged into the stereo jack mounted on the control console back plate. The control console power cord is plugged into a grounded NEMA 5-15R 120 VAC receptacle.

## SCOREBOARD OPERATION

The MM-368 Scoreboard is operated by the control console. **No scoreboard functions will operate without connecting the control console.** Figure 11 shows the keypad layout on your control console. The keypad functions are described in the text below the figure.

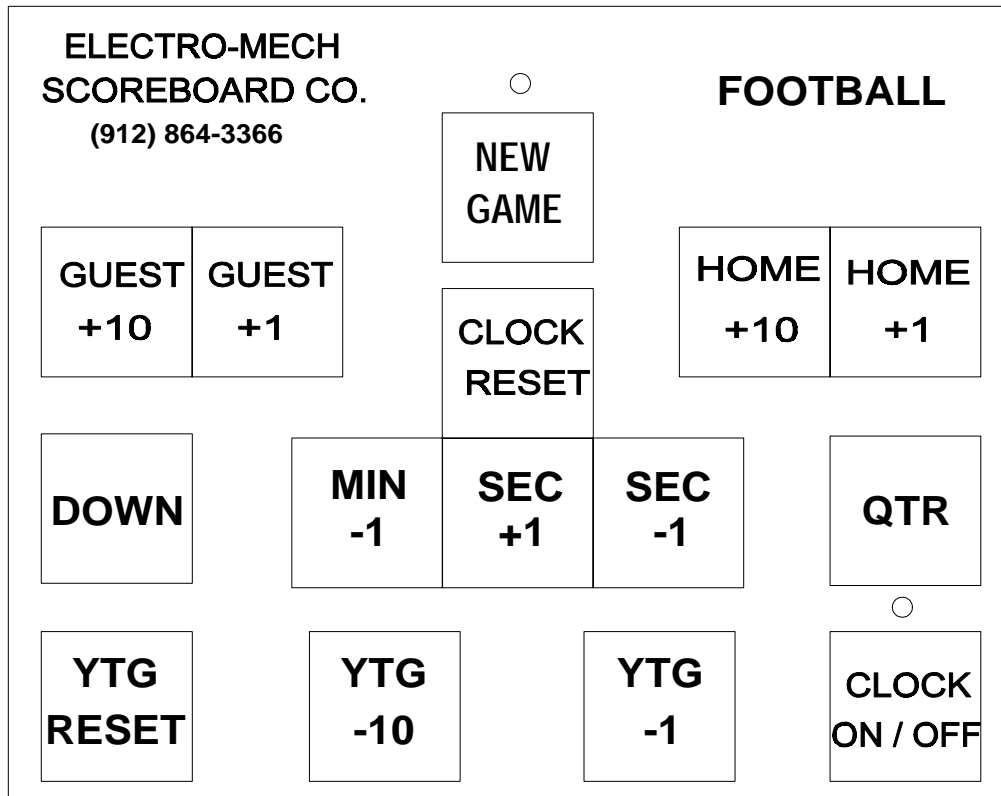

**Figure 11 Keypad Layout**

### Control Console Key Functions

1. **GUEST +1** – This key increments the Guest score by 1.
2. **HOME +1** – This key increments the Home score by 1.
3. **GUEST +10** – This key increments the Guest score by 10.
4. **HOME + 10** – This key increments the Home scores by 10.

5. **QTR** – This key increments the period.
6. **CLOCK ON/OFF** – This key toggles the clock on and off.
7. **MIN -1** – This key decreases the clock by one minute.
8. **SEC +1** – This key increases the clock by one second.
9. **SEC -1** – This key decreases the clock by one second.
10. **CLOCK RESET** – This key is used to cycle the clock between the 15, 30, and 60 minute settings.
11. **NEW GAME** – This key can be used to reset all scoreboard functions. Press **NEW GAME** and, within two seconds, press **CLOCK RESET**.

The DOWN, YTG RESET, YTG -10, and YTG -1 keys are not used with the MM-368 scoreboard.

### **HAND HELD CLOCK CONTROL UNIT OPERATION**

The hand held clock control unit has an attached cable which is plugged into a jack on the control console back plate labeled **Clock Hand held**. It has one button which is used to toggle the clock on and off.

You should reset the scoreboard each time that it is turned on. Test out all the functions to ensure that the scoreboard is operating properly. **Electro-Mech Scoreboard Company strongly advises that you unplug the control console, disconnect the extension cable at the control console, and turn the power to the scoreboard off when the scoreboard is not in use. The control console can not turn the scoreboard off.** This action will help protect the scoreboard and control console from power surges and lightning strikes.



## SERVICING THE SCOREBOARD

While your scoreboard was designed for years of trouble-free operation, some problems may occasionally occur. Our trained personnel at Electro-Mech Scoreboard Company are ready to answer your questions from Monday to Friday during the hours of 8 AM to 5 PM Eastern Standard Time. Be sure to know your scoreboard model number when calling. Scoreboard replacement parts, including lamps, are always available. Electro-Mech Scoreboard Company can repair the control console and plug in modules at a significant savings when compared to the price of new units. Our convenient toll free number is listed at the bottom of every page in this manual.

As seen in figure 12, the plug in modules MC-01 and MSF-01, fuses, connection points for the power and control cable, and a test jack are located behind the access panel.

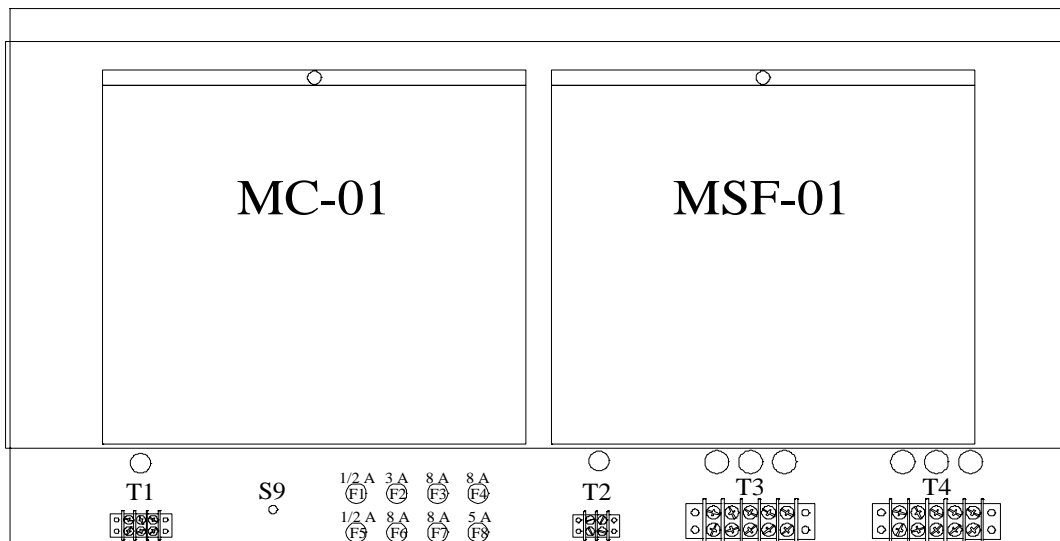

**Figure 12 Access Panel Components**

The plug in module MSF-01 operates VISITOR SCORE and HOME SCORE. The plug in module MC-01 operates the CLOCK, PERIOD, and the horn.

**FUSES**

FUSE	RATING	FUNCTION
F1	1/2 A 250 V	CONTROL LINE
F2	3 A 250 V	HORN
F3	8 A 250 V	MINUTES
F4	8 A 250 V	SECONDS
F5	1/2 A 250 V	CONTROL LINE
F6	8 A 250 V	HOME SCORE
F7	8 A 250 V	GUEST SCORE
F8	5 A 250 V	PERIOD

**CONNECTION POINTS**

TERMINAL STRIP	FUNCTION
T-1	control cable connection
T-2	horn connection
T-3	MOV (surge protection)
T-4	power cable connection
S-9	test jack

**PLUG IN MODULE REPLACEMENT**

Each module has four bottom plugs which mate with sockets in the scoreboard. A screw located at the top of the module holds it against the scoreboard cabinet. Simply remove the screw and pull the module upward to unseat the module. **To avoid damage to the plug in module, always turn off the power to the scoreboard when removing or replacing it.**

**LAMP REPLACEMENT**

Replacing lamps may be the only service you ever perform on your Electro-Mech scoreboard. The lamps are accessed by removing the protective mask covering each lamp bank. **To avoid damage to the plug in module, always turn off the power to the scoreboard when changing lamps.** We recommend using a felt pen or tape to mark lamps that will not light. This scoreboard uses 15 watt medium base lamps (also called 15A15 lamps). **Never replace these with higher wattage lamps.**

## ELECTRO-MECH SCOREBOARD CO. FIVE YEAR LIMITED WARRANTY

THE ELECTRICAL COMPONENTS OF ALL ELECTRO-MECH SCOREBOARDS ARE GUARANTEED FOR A PERIOD OF FIVE (5) YEARS FROM THE DATE OF INVOICE AGAINST DEFECTS IN WORKMANSHIP OR MATERIAL AND WILL BE REPLACED OR REPAIRED WITHOUT COST TO THE OWNER PROVIDED THE EQUIPMENT OR PARTS ARE RETURNED POSTAGE-PAID TO THE FACTORY IN WRIGHTSVILLE, GA. SHIPPING BACK TO THE OWNER WILL BE VIA UPS GROUND SERVICE EXCEPT WHEN AIR OR SPECIAL METHOD OF RETURN IS SPECIFIED BY THE OWNER, IN WHICH CASE SHIPPING WILL BE FREIGHT COLLECT.

EXCLUDED FROM THIS WARRANTY ARE LAMPS, FUSES AND SOCKETS.

THIS WARRANTY DOES NOT INCLUDE LABOR CHARGES INCURRED IN THE REMOVAL OF COMPONENT PARTS, SERVICE CALLS, OR DAMAGES RESULTING FROM IMPROPER INSTALLATION, IMPROPER OPERATION, OR PROBLEMS CAUSED BY ANY REPAIR, ALTERATION OR MODIFICATION OF THE SCOREBOARD NOT PERFORMED BY ELECTRO-MECH.

EQUIPMENT WHICH IS SUBJECTED TO ACCIDENT, NEGLECT, ABUSE, MISUSE OR OTHER NATURAL DISASTERS, INCLUDING BUT NOT LIMITED TO FIRE, WIND, LIGHTNING, OR FLOOD, IS NOT COVERED BY THIS GUARANTEE.