

---

## ELECTRO-MECH SCOREBOARD CO.

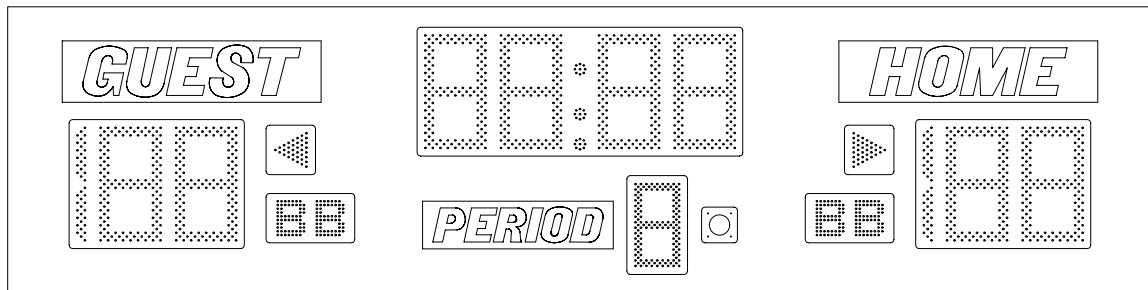

## MODEL 2370 BASKETBALL SCOREBOARD

### OWNER'S HANDBOOK

Thank you for choosing an Electro-Mech Scoreboard for your athletic complex. We are confident that your new scoreboard will give many years of reliable service.

Rev. 4 Revised: 04/27/2006

## TABLE OF CONTENTS

<b>2370 BASKETBALL SCOREBOARD SPECIFICATIONS .....</b>	<b>3</b>
<b>SCOREBOARD INSTALLATION .....</b>	<b>4</b>
<b>MECHANICAL INSTALLATION .....</b>	<b>4</b>
Mounting the Scoreboard .....	4
Attaching the Optional Bottom Sponsor Panel .....	5
<b>ELECTRICAL INSTALLATION .....</b>	<b>6</b>
Power Connection .....	6
ScoreLink 200 .....	7
Control Cable Installation .....	7
Control Console Connections .....	9
Goal Lights Installation .....	9
Installation of Two or More Scoreboards at the Same Site .....	9
<b>SCOREBOARD OPERATION .....</b>	<b>10</b>
<b>SCOREBOARD STARTUP .....</b>	<b>10</b>
<b>GAME TIME OPERATION .....</b>	<b>10</b>
Control Console Key Functions .....	12
Horn and Goal Lights Operation .....	16
Hand Held Clock Control Unit Operation .....	16
<b>SCOREBOARD SHUTDOWN .....</b>	<b>16</b>
<b>SERVICING THE SCOREBOARD .....</b>	<b>17</b>
<b>COMPONENT REPLACEMENT .....</b>	<b>17</b>
LED Digits And Indicators Replacement .....	17
Horn Replacement .....	19
LED Driver Module Replacement .....	20
LED Power Supply Module Replacement .....	21
<b>WARRANTY .....</b>	<b>23</b>

---

## 2370 BASKETBALL SCOREBOARD SPECIFICATIONS

**GENERAL:** This ETL listed scoreboard includes the scoreboard cabinet, mounting hardware, control console, 10 ft. extension cable, and junction box.

**DIMENSIONS:** 14' L x 42" H x 6" D (The optional bottom sponsor panel measures 14' L x 21" H x 6" D)

**WEIGHT:** 155 lbs (The optional bottom sponsor panel weighs 63 lbs)

**SCOREBOARD CONSTRUCTION:** The outer frame is made from extruded aluminum. Internal structural parts may be extruded aluminum or formed from aluminum sheet. The face and back are made from aluminum sheet. The face is finished with enamel paint. Black is the standard face color. White is the standard color for the sponsor panel. The captions are white on a gray background. The optional bottom sponsor panel is mounted on a separate extruded aluminum frame.

**DISPLAY:** The 2370 basketball scoreboard displays HOME and GUEST scores to 199, a 99:59 clock with 1/10<sup>th</sup> of a second timing below 1:00, PERIODS to 4, HOME and GUEST bonus and possession symbols. It has an internal horn.

**DIGITS AND SYMBOLS:** Light emitting diodes mounted on printed circuit boards form the digits and symbols. The clock is formed with 16" red digits, the HOME and GUEST scores are formed with 16" yellow digits, the PERIOD is formed with a 12" green digit, 5" bonus symbols are green, the 5" possession symbols and colon / decimal symbols are red.

**POWER REQUIREMENTS:** **Scoreboard** - 120 VAC, 1 A, 60 Hz. The scoreboard has an attached 6 ft. power cord. **Control Console** - 120 VAC, 0.5 A, 60 Hz

**SCOREBOARD ELECTRONICS:** 100% solid state fully enclosed.

**CONTROL CONSOLE:** The control console features a microprocessor, 37 key sealed membrane keypad, a LCD display, and an attached 6 foot power cord. The console housing consists of ABS plastic base and top pieces with a steel back plate.

**CONTROL CABLE:** The cable has two 22 AWG stranded copper conductors with semi-rigid PVC insulation. It also has a braided shield and a foil shield. The polyethylene jacket is rated at 300 volts. The cable is direct burial rated and measures approximately 1/4" in diameter. This item is sold separately from the scoreboard.

**JUNCTION BOX AND EXTENSION CABLE:** A 4 1/4" x 2 1/4" x 2" junction box with a 1/4" stereo jack mounted on the face plate is attached to the control cable at the point of operation. A 10 ft. extension cable connects the control console to the junction box.

**SCORELINK 200 RF MODEM SYSTEM:** This accessory can be used in place of control cable and junction box for this scoreboard without internal modifications to the scoreboard or the control console. Refer to the SCORELINK 200 RF MODEM SYSTEM OWNER'S HANDBOOK for more information.

**WARRANTY:** Five year limited warranty.

## SCOREBOARD INSTALLATION

This part of the manual describes the mechanical and electrical installation of the scoreboard.

One of the items listed below must be purchased in order to complete the installation:

- Control cable (length dependent upon installation site layout)
- ScoreLink 200 RF Modem System

Items not provided by Electro-Mech Scoreboard Company that are necessary for installation:

- Wall fasteners
- A grounded NEMA 5-15R 120 VAC receptacle for the control console at the scorekeeper's table.

Electro-Mech Scoreboard Company performs installations in some areas. In other areas, we can help you contact an independent installer. In areas in which installation service is not available from Electro-Mech Scoreboard Company, we will make every effort to answer your installation questions. Qualified personnel should perform the scoreboard installation. Consult national and local codes before installation.

## MECHANICAL INSTALLATION

The mechanical installation includes mounting the scoreboard on the wall and attaching the optional bottom sponsor panel (if purchased) to the scoreboard.

### Mounting the Scoreboard

The following steps describe how to mount the scoreboard on the wall:

1. There are two hanger brackets attached to the scoreboard near the top of the cabinet on the rear side. They may have been rotated down to facilitate shipping. Rotate the hanger brackets so that they protrude past the top of the scoreboard and tighten the bolts.
2. Lift the scoreboard to the desired location. There are two eyebolts mounted at the top of the cabinet that can be used to lift the scoreboard into place. **Be sure to mount the center of the scoreboard close enough to the wall receptacle so that you can plug in the 6 ft. power cord.**
3. Insert lag bolts or other suitable fasteners through the hanger brackets and fasten the scoreboard to the wall. Figure 1 shows the mounting point locations for model 2370.

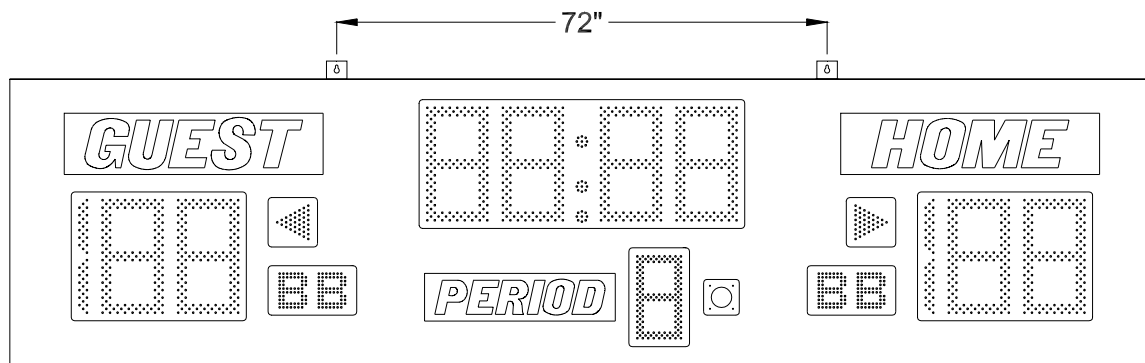
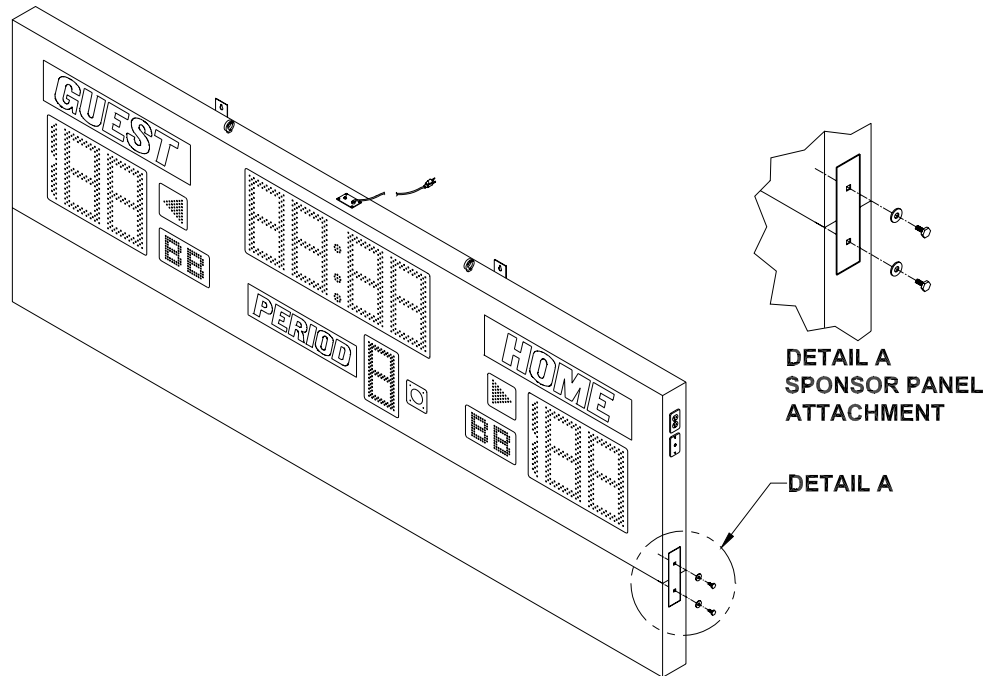

**Figure 1 Model 2370 Mounting Points**

#### **Attaching the Optional Bottom Sponsor Panel**

Two attachment plates, four bolts, and four washers are provided to attach the sponsor panel to the bottom of the scoreboard. The attachment points are located on the sides of the scoreboard and sponsor panel cabinets. The following steps describe how to attach the sponsor panel to the scoreboard:

1. Raise the sponsor panel to the bottom of the scoreboard.
2. Fasten an attachment plate to the right side of the scoreboard and sponsor panel using the provided washers and bolts as shown in figure 2.
3. Fasten the other attachment plate to the left side of the scoreboard and sponsor panel in the same manner.



**Figure 2 2370 with Bottom Sponsor Panel Attached**

## **ELECTRICAL INSTALLATION**

We recommend a qualified electrician perform the needed electrical connections to ensure proper operation of the scoreboard. These connections include connecting the scoreboard to a power source, installing the ScoreLink 200 or the control cable, and connecting the control console. The installation of goal lights and multiple scoreboards is also described in this section.

### **Power Connection**

The scoreboard requires 120 VAC service at the scoreboard to operate properly.

**Maximum power consumption of Model 2370: 120 Watts.** The scoreboard has a 6 ft. attached power cord located at the top of the cabinet. Plug the power cord into a grounded NEMA 5-15R receptacle. The receptacle should be controlled by a separate circuit breaker so that the scoreboard can be turned off without turning off other electrical devices in the facility. Figure 3 shows the electrical connection points on the scoreboard.

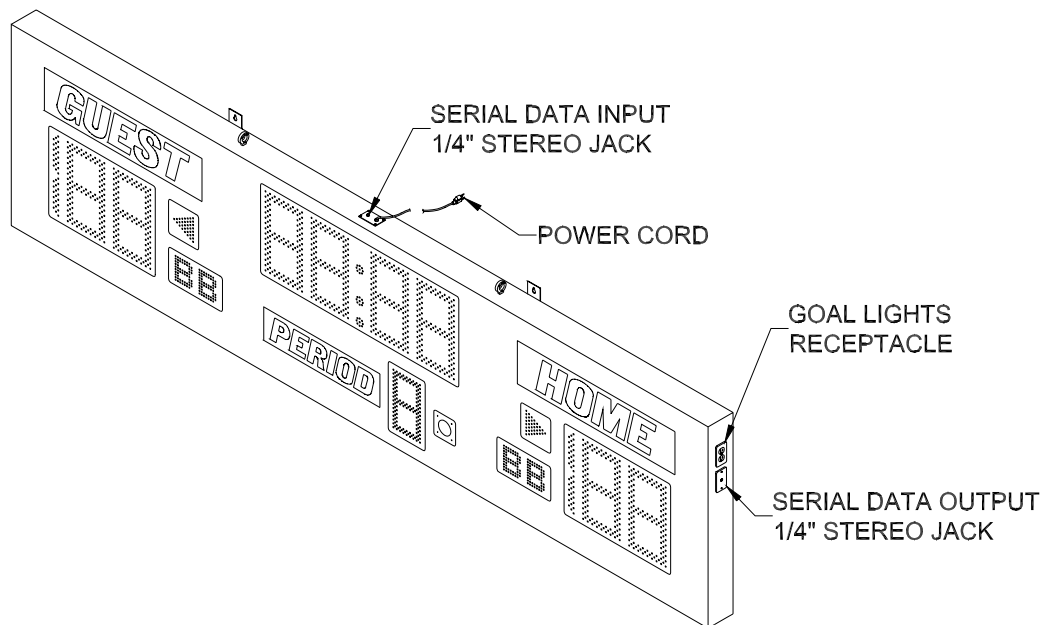

**Figure 3 Electrical Connection Points**

### ScoreLink 200

The SCORELINK 200 RF MODEM SET is intended to eliminate the control cable between the scoreboard and the control console on Electro-Mech Scoreboard MM and MP series scoreboards. If you have purchased this accessory, disregard the section of this manual titled **Control Cable Installation**. Refer to the SCORELINK 200 RF MODEM SET OWNER'S HANDBOOK for installation instructions.

### Control Cable Installation

The control cable connects the scoreboard to the control console. A small junction box with a 1/4" stereo jack mounted on the face plate is attached to the control cable at the point of operation of the scoreboard. This junction box should be securely mounted within ten feet of the rear of the control console. Most customers order the control cable with the junction box attached. Some customers prefer to attach the junction box after the cable is installed. Those customers must solder the control cable to the 1/4" stereo jack. Figure 4 shows the control cable wire connection points on the rear of the 1/4" stereo jack.

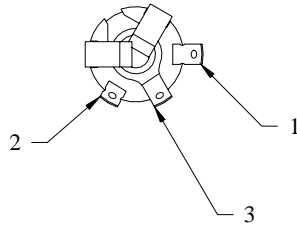

PIN 1 - BLACK WIRE  
 PIN 2 - RED WIRE  
 PIN 3 - SHIELD WIRE

#### Figure 4 1/4" Stereo Jack Wiring Diagram

A 1/4" stereo plug is attached to the scoreboard end of the control cable. It is inserted into the 1/4" stereo jack mounted on top of the scoreboard. Most customers order the control cable with the 1/4" stereo plug attached. Some customers prefer to attach it after the cable is installed. Those customers must solder the 1/4" stereo plug to the cable according to the figure 5. Unscrew the stereo plug cover from the plug body to expose the contact pins.

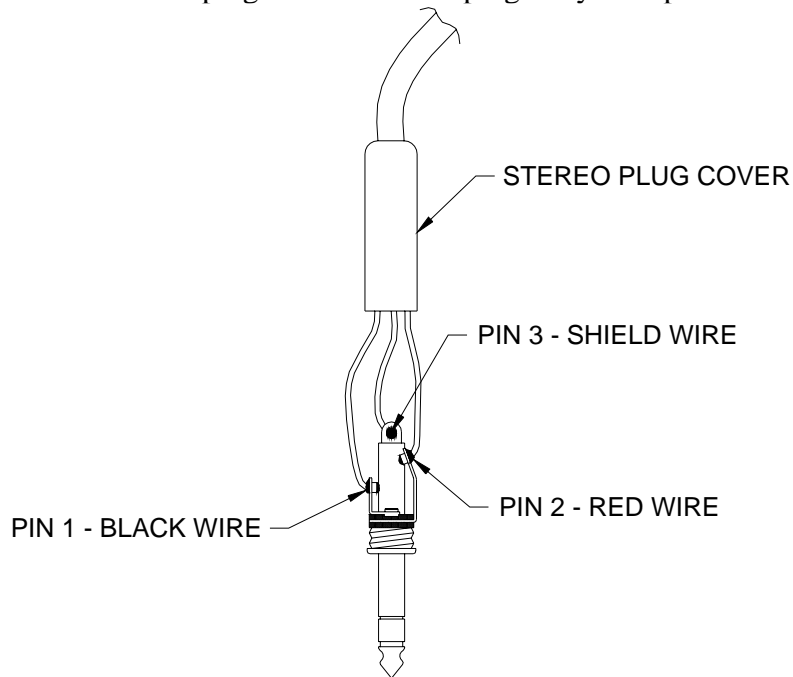

#### Figure 5 1/4" Stereo Plug Wiring Diagram



### Control Console Connections

The 10 ft. extension cable has two molded ¼” stereo plugs attached to it. It is used to connect the control console to the junction box. The following steps describe how to connect the control console:

1. Plug one end of the extension cable into the ¼” stereo jack on the junction box or the ScoreLink 200 Transmitter, if purchased.
2. Plug the other end into one of the four ¼” stereo jacks mounted on the control console back plate.
3. Plug the control console power cord into a grounded NEMA 5-15R 120 VAC receptacle.

This product is equipped with a 3-wire grounding type plug, a plug having a third (grounding) pin. This plug will only fit into a grounding-type power outlet. This is a safety feature. If you are unable to insert the plug into the outlet, contact a qualified electrician to replace your obsolete outlet. Do not defeat the purpose of the grounding-type plug.

### Goal Lights Installation

This scoreboard can control a set of goal lights. The following steps describe how to install a goal light:

1. Mount the goal light in the desired location.
2. Splice wires (not provided) to the two wire leads of the goal light.
3. Attach a polarized plug to the other end of the wires.
4. Insert the plug into the goal light receptacle on the right side of the scoreboard cabinet. The goal light receptacle is protected by a 1 amp fuse. Do not insert bulbs greater than 40 watts in the goal lights.

### Installation of Two or More Scoreboards at the Same Site

It is possible to operate multiple scoreboards or shot timers from the same console. Either install a control cable between each unit and the control console or install a ScoreLink 200 Transmitter at the control console and a ScoreLink Receiver at each scoreboard or shot timer. Additional scoreboards and shot timers can be controlled by connecting a control cable from the serial data output ¼” stereo jack on the right side of an installed scoreboard cabinet (figure 3) to the serial data input ¼” stereo jack on the top of the additional scoreboard or shot timers. Attach ¼” stereo plugs on each end of these cables according to figure 5. **Never splice the control cables together or connect them to the same junction box.** Each scoreboard will need to be connected to 120 VAC service.

## SCOREBOARD OPERATION

### SCOREBOARD STARTUP

1. Place the circuit breaker for the scoreboard in the **ON** position.
2. Plug one end of the extension cable into ¼" stereo jack on the junction box or the ScoreLink 200 Transmitter, if purchased.
3. Plug the other end into the ¼" stereo jack mounted on the control console back plate.
4. Plug the control console power cord into a grounded NEMA 5-15R 120 VAC receptacle.
5. If a ScoreLink 200 RF MODEM SYSTEM is installed with this scoreboard, plug the wall mount DC power supply into a grounded NEMA 5-15R 120 VAC receptacle and the male plug on the end of the attached cable into the Power jack on the Transmitter.

### GAME TIME OPERATION

This scoreboard is operated with a 37-key control console. Figure 6 shows the keypad layout on the control console.

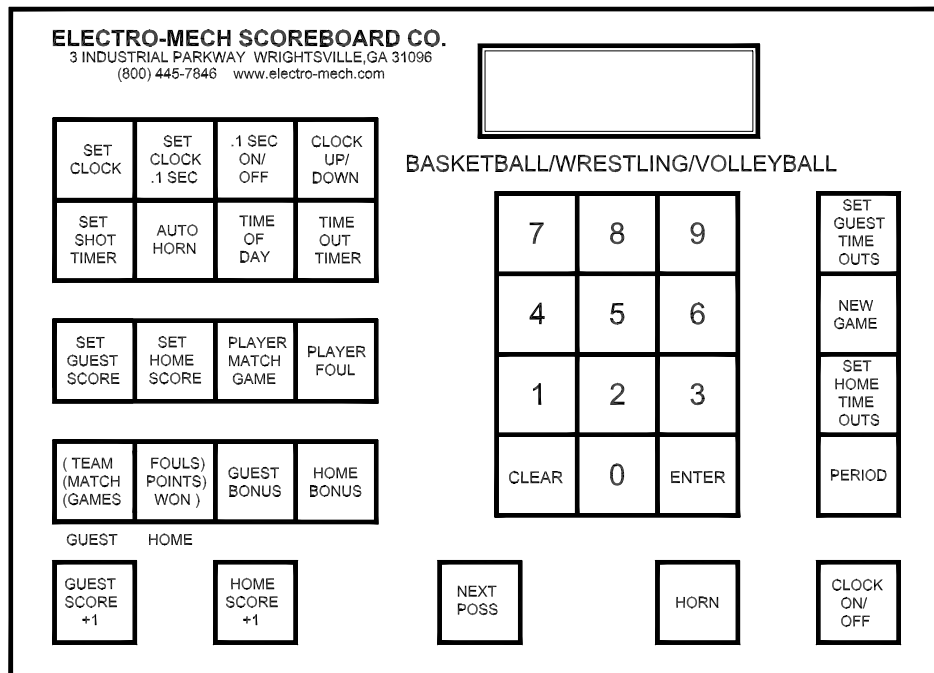

**Figure 6 Keypad Layout**

Immediately after the control console power cord is plugged into a 120 VAC source, the console LCD display will read:

```
ELECTRO-MECH VER
SCOREBOARD B60
```

After a few seconds the display will read:

```
000 D15:00 0 000
00 00 0 00
```

The scoreboard will display:

```
CLOCK – 15:00
GUEST – 0
HOME – 0
```

The control console LCD display shows the same information as the scoreboard. Note: In some functions a 0 will be blanked on the scoreboard, but not on the console. Because this console program is used for a number of models of scoreboards, some functions will appear on the console LCD display that are not present on the scoreboard. Figure 7 explains the LCD display layout.

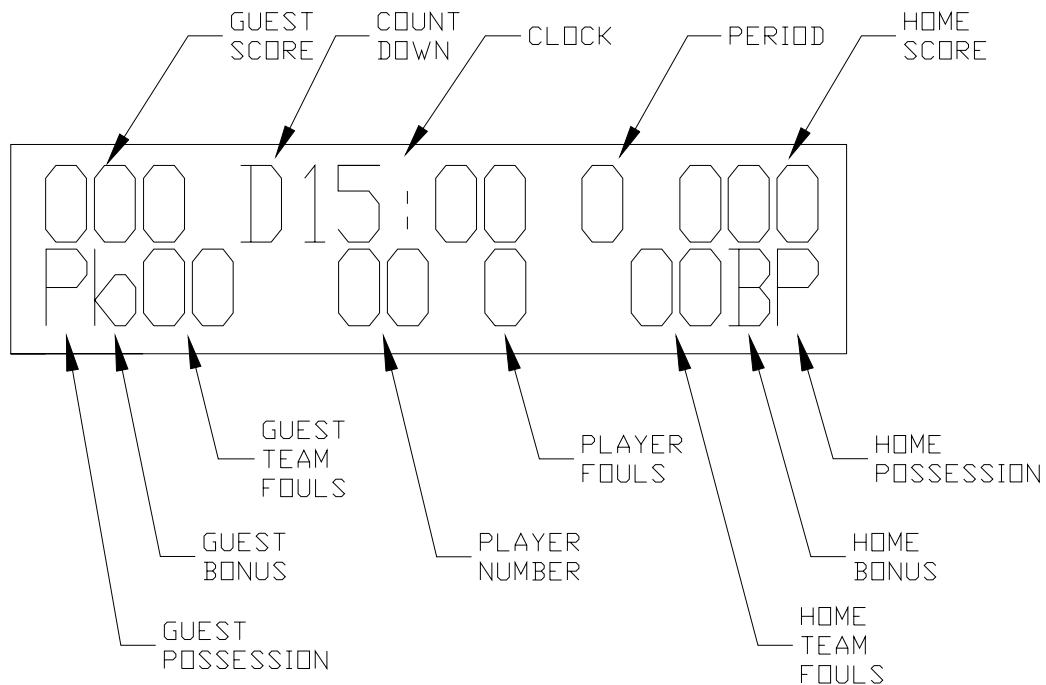

**Figure 7 Control Console LCD Display**

## Control Console Key Functions

1. **SET CLOCK** – This key sets the time displayed on the scoreboard clock. Press [SET CLOCK]. The console LCD display will read:

```
000 D15: 00 0 000
SET CLK <00: 00>
```

Press the keypad numbers for the time, [ENTER]. Example: Press [SET CLOCK], [6], [0], [0], [0], [ENTER] on the control console. 60:00 will be displayed on the clock section of the scoreboard.

2. **SET CLOCK .1 SEC** – This key is used to set the scoreboard clock to a time less than one minute when tenth of a second accuracy is required. Press [SET CLOCK .1 SEC]. The console LCD display will read:

```
000 D15: 00 0 000
SET SEC <00. 0>
```

Press the keypad numbers for the time, [ENTER]. Example: Press [SET CLOCK .1 SEC], [5], [3], [8], [ENTER] on the control console. 53.8 will be displayed on the clock section of the scoreboard.

3. **.1 SEC ON/OFF** – This key is used to enable or disable the display of tenths of seconds on the scoreboard. The use of this key has a visible effect on the scoreboard only if the game clock is less than one minute. This mode is enabled when the control console is turned on. If it is disabled, the LCD display on the control console will still show 1/10<sup>th</sup> second timing, but the scoreboard will not display it. To turn this function off, press [.1 SEC ON/OFF]. The console LCD display will read:

```
CLOCK   ON   <1>
.1 SEC  OFF  <0>
```

Press [0], [ENTER] on the control console.

4. **CLOCK UP/DOWN** – The clock can be set up to either count up or count down. The control console is set to the clock down mode when it is turned on. To make the clock count up, press [CLOCK UP / DOWN]. The console LCD display will read:

```
GAME    UP   <1>
CLOCK   DOWN <0>
```

Press [1], [ENTER] on the control console. The letter D in front of the game time on the console LCD will be replaced with the letter U to indicate that the clock is in the count up mode. To reset the clock to count down mode, press [CLOCK UP / DOWN], [0], [ENTER] on the control console.

5. **SET SHOT TIMER** – The console is programmed with two timers. The timers should be set prior to the start of a game. The shot timer is preset to 30 seconds. The out of bounds timer is preset to 5 seconds. To change either one of these times, press [SET SHOT TIMER]. The console LCD display will read:

```
000 D15:00 0 000
ST RESET <30>
```

Press the keypad numbers to set shot timer, [ENTER]. The LCD display will then read:

```
00 D15:00 0 00
ST 0B RESET <05>
```

Press the keypad numbers to set the out of bounds timer, [ENTER].

6. **AUTO HORN** – This key allows the operator to control the end of period horn and the time out horn. The horn sounds for two seconds when the clock reaches 0:00 at the end of the period. The end of period horn can be disabled by pressing [AUTO HORN]. The console LCD display will read:

```
GAME PRESS<1>ON
HORN PRESS<0>OFF
```

Press [0], [ENTER] to disable the horn. The console LCD display will then read:

```
T-0 PRESS<1>ON
HORN PRESS<0>OFF
```

The time out horn is normally disabled. To enable the horn to sound at the end of the time out, press [1], [ENTER] on the control console.

7. **TIME OF DAY** – The time of day can be displayed on the clock section of the scoreboard. **THE GAME CLOCK WILL BE INOPERABLE UNTIL THE TIME OF DAY FUNCTION IS TURNED OFF.** To turn the time of day clock on, press [TIME OF DAY]. The console LCD display will read:

```
TIME OF ON <1>
DAY CLOCK OFF<0>
```

Press [1], [ENTER] on the control console. The console LCD display will then read:

```
00 C12:00 0 00
SET CLK <12:00>
```

Press the keypad numbers for the time, [ENTER]. The letter C will be displayed on the console LCD display to the left of the time to indicate that the time of day function is active. The scoreboard will display the time of day.

8. **TIME OUT TIMER** – To set the Time Out timer, press [TIME OUT TIMER]. The console LCD display will read:

```
000 D15: 00 0 000
SET T-0 <1: 00>
```

Press the keypad numbers for the time, [ENTER]. After the ENTER key is pressed, the letter T is displayed to the left of the time on the LCD display and the TIME OUT TIMER immediately begins to count down to 0. The scoreboard will not display the Time Out time.

9. **SET GUEST SCORE** – To set the guest score, press [SET GUEST SCORE]. The console LCD display will read:

```
000 D15: 00 0 000
GUEST SCORE<000>
```

Press the keypad numbers for the score, [ENTER]. **EXAMPLE:** To set the guest score to 53, press [SET GUEST SCORE], [5], [3], [ENTER].

10. **SET HOME SCORE** – To set the home score, press [SET HOME SCORE]. The console LCD display will read:

```
000 D15: 00 0 000
HOME SCORE <000>
```

Press the keypad numbers for the score, [ENTER]. **EXAMPLE:** To set the home score to 75, press [SET HOME SCORE], [7], [5], [ENTER].

11. **GUEST BONUS** – There are two Guest Bonus indicators on the scoreboard. Guest Bonus 1 is located directly below the red Possession indicator. Guest Bonus 2 is located to the right of Guest Bonus 1. When the [GUEST BONUS] key is pressed, the Guest Bonus 1 indicator on the scoreboard turns on and 'b' is displayed on the console LCD display as shown below.

```
000 D15: 00 0 000
b00 00 0 00
```

When the [GUEST BONUS] key is pressed a second time, the Guest Bonus 1 and 2 indicators will be illuminated and 'B' is displayed on the console LCD display as shown below.

```
000 D15: 00 0 000
B00 00 0 00
```

When the [GUEST BONUS] key is pressed a third time, both Guest Bonus indicators are turned off. There is no symbol in the Guest Bonus field on the console LCD display.

12. **HOME BONUS** – There are two HOME Bonus indicators on the scoreboard. HOME Bonus 1 is located directly below the red Possession indicator. HOME Bonus 2 is located to the left of HOME Bonus 1. When the [HOME BONUS] key is pressed, the HOME Bonus 1 indicator on the scoreboard turns on and ‘b’ is displayed on the console LCD display as shown below.

```
000 D15: 00 0 000
  00  00 0  00b
```

When the [HOME BONUS] key is pressed a second time, the HOME Bonus 1 and 2 indicators will be illuminated and ‘B’ is displayed on the console LCD display as shown below.

```
000 D15: 00 0 000
  00  00 0  00B
```

When the [HOME BONUS] key is pressed a third time, both HOME Bonus indicators are turned off. There is no symbol in the HOME Bonus field on the console LCD display.

13. **GUEST SCORE +1** – This key is used to increment the guest score by 1.
14. **HOME SCORE +1** – This key is used to increment the home score by 1.
15. **NEXT POSS** – This key toggles the possession indicators between guest and home. When the [NEXT POSS] key is pressed for the first time, the HOME Possession indicator is illuminated and ‘P’ is displayed on the console LCD display as shown below.

```
000 D15: 00 0 000
  00  00 0  00 P
```

When the [NEXT POSS] key is pressed a second time, the HOME Possession indicator turns off, the GUEST Possession indicator turns on, and ‘P’ is displayed on the console LCD display as shown below.

```
000 D15: 00 0 000
P 00  00 0  00
```

16. **HORN** – This key is used to sound the horn for ½ second.
17. **CLOCK ON/OFF** – This key is used to start and stop the clock.
18. **PERIOD** – This key is used to increment the period by 1.

19. **NEW GAME** – This key is used to reset all the scoreboard functions to their default settings. To reset the scoreboard, press [NEW GAME]. The console LCD display will read:

RESET	YES<1>
SCOREBOARD	NO<0>

Press [1], [ENTER] on the control console. The scoreboard will reset its functions.

20. **CLEAR** – This key clears the information being entered into the control console.

The PLAYER MATCH GAME, PLAYER FOUL, (TEAM (MATCH (GAMES GUEST, FOULS) POINTS) WON) HOME, SET GUEST TIME OUTS, and SET HOME TIME OUTS keys are not used with the 2370 scoreboard.

### Horn and Goal Lights Operation

The horn sounds for two seconds when the game clock reaches 0 seconds. It sounds for 0.5 seconds when the [HORN] key is pressed. The optional goal lights illuminate when the horn sounds.

### Hand Held Clock Control Unit Operation

The hand held clock control unit has an attached cable that is plugged into a jack on the control console back plate labeled **Clock Hand held**. It has one button that is used to toggle the clock on and off.

You should reset the scoreboard each time that it is turned on. Test out all the functions to ensure that the scoreboard is operating properly.

## SCOREBOARD SHUTDOWN

1. Place the circuit breaker for the scoreboard in the **OFF** position.
2. Unplug the control console power cord.
3. Unplug the extension cable.
4. If a ScoreLink 200 RF MODEM SYSTEM is installed with this scoreboard, unplug the Transmitter's wall mount power supply.
5. Store the control console and ScoreLink 200 Transmitter in a dry location. These units are not waterproof.

Proper scoreboard shutdown will help protect the scoreboard and control console from power surges and lightning strikes.



## SERVICING THE SCOREBOARD

While your scoreboard was designed for years of trouble-free operation, some problems may occasionally occur. Electro-Mech Scoreboard Company offers onsite service in some areas. In other areas, we can help you contact an independent service technician. In areas in which service is not available from Electro-Mech Scoreboard Company, we will make every effort to answer your questions. Our trained personnel at Electro-Mech Scoreboard Company are ready to answer your questions from Monday to Friday during the hours of 8 AM to 5 PM Eastern Standard Time. Be sure to know your scoreboard model number when calling. Scoreboard replacement parts are always available. Damaged parts can usually be repaired at a significant cost savings. Our convenient toll free number is listed at the bottom of every page in this manual.

## COMPONENT REPLACEMENT

### LED Digits And Indicators Replacement

The LEDs that form digits and indicators are soldered on circuit boards mounted behind metal masks. Do not attempt to replace individual LEDs. In case of a malfunction, the entire LED circuit board must be removed. **To avoid damage to the LED driver module, always turn off the power to the scoreboard when removing or replacing LED digits and indicators.** Figure 8 shows the components of a LED digit assembly. LED indicator assemblies are similar in construction.

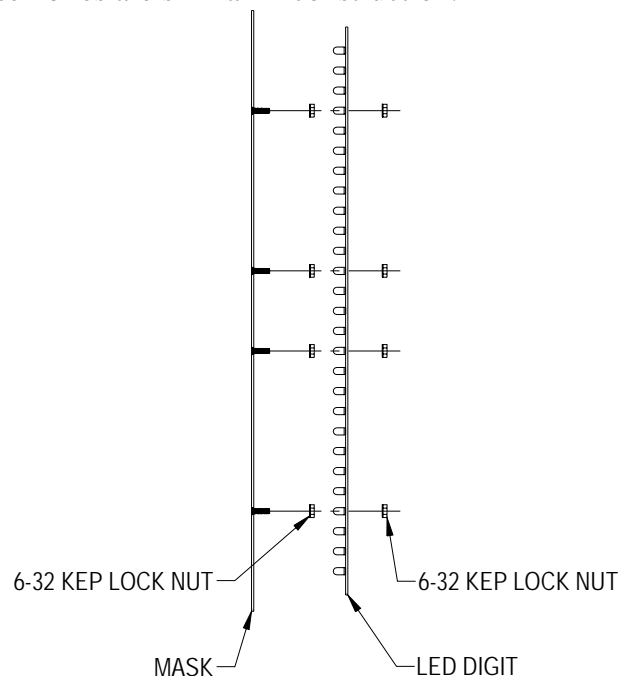

**Figure 8 LED Digit Assembly**

1. Remove the machine screws that fasten the mask to the face of the scoreboard.  
**Caution: Support the mask with before removing the last screw. The ribbon cable that connects to the rear of the circuit board is not designed to support the weight of the assembly.**
2. Disconnect the ribbon cable from the rear of the circuit board. **Caution: Do not let the cable hang outside of the scoreboard. It is easily cut by sharp metal edges. Damage to the ribbon cable may create short circuit paths that will damage the LDM1 LED driver module.**
3. Place the assembly on a flat surface and remove the 6-32 kep lock nuts that hold the circuit board in place.
4. Remove the circuit board.
5. Align the mounting holes in the circuit board with the threaded studs on the mask and install the replacement digit on the mask.
6. Plug the ribbon cable onto the header on the back of the circuit board.
7. There are two circuit boards that may be used for the BONUS indicators. One circuit board has two headers and may be used for either BONUS 1 or BONUS 2. As seen in figure 9, inserting the ribbon cable IDC socket on the top header makes the circuit board operate as BONUS 1. Inserting the ribbon cable IDC socket on the bottom header makes the circuit operate as BONUS 2. The other circuit board has one header and may only be used for BONUS 1.

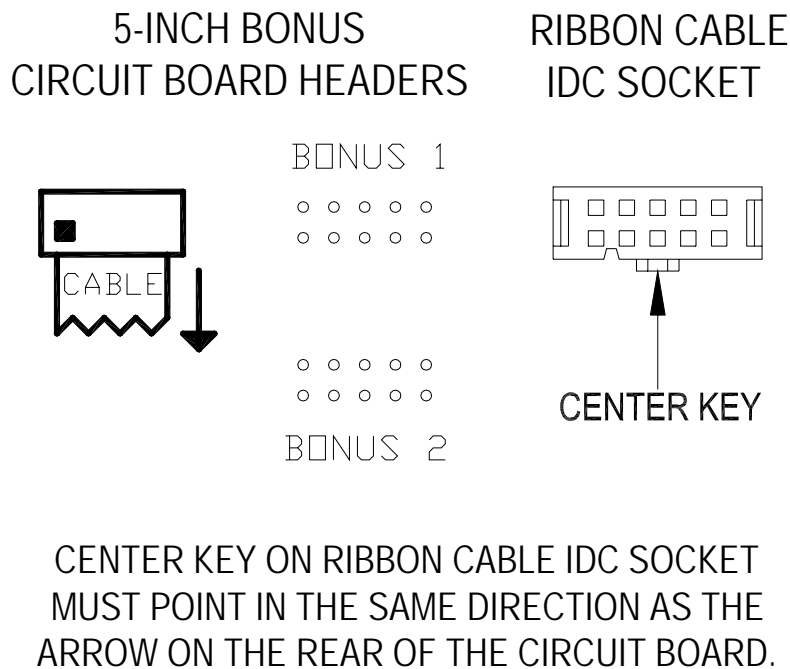
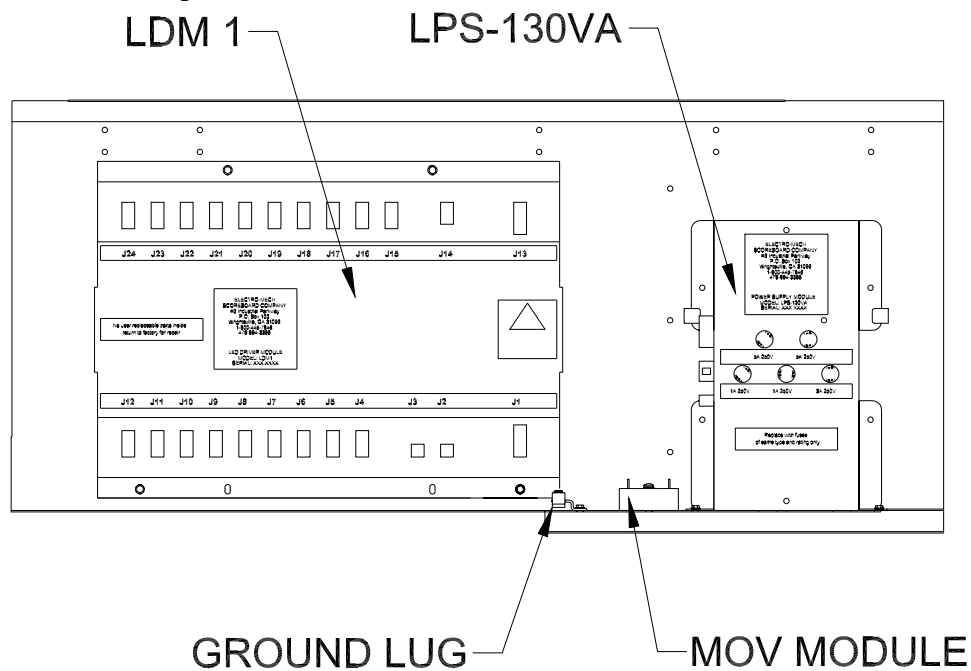

**Figure 9 BONUS 1 and BONUS 2 Ribbon Cable Connection Diagram**

## Horn Replacement

1. Remove the machine screws that fasten the mask to the face of the scoreboard.
2. Pull the horn assembly out of the scoreboard and cut the two wires leading up to the rear of the horn assembly.
3. Splice the new horn assembly wires to the two wires inside the scoreboard.
4. Install the horn assembly and fasten it to the scoreboard face using the machine screws.

All other components are located behind the PERIOD panel. Figure 101 shows the view behind the PERIOD panel.



**Figure 10 SCOREBOARD ELECTRONICS**

## LDM1 LED DRIVER MODULE FUNCTIONS

DRIVER MODULE JACK	FUNCTION #1	FUNCTION #2	FUNCTION #3	FUNCTION #4
J1	DRIVER MODULE DC POWER INPUT #1			
J2	SERIAL DATA INPUT			
J3	SERIAL DATA OUTPUT			
J4	CLOCK SECONDS UNITS			
J5	CLOCK SECONDS TENS			
J6	CLOCK MINUTES UNITS			
J7	HOME SCORE UNITS			
J8	HOME SCORE TENS	HOME SCORE HUNDRED		
J9	GUEST SCORE UNITS			
J10	HOME FOULS UNITS	HOME FOULS TENS		
J11	GUEST FOULS UNITS			
J12	PLAYER NUMBER UNITS			
J13	DRIVER MODULE DC POWER INPUT #2			
J14	HORN / GOAL LIGHT RELAY CONTROL			
J15	GUEST POSSESSION	GUEST BONUS 1	GUEST BONUS 2	DECIMAL / COLON
J16	QUARTER			
J17	CLOCK MINUTES TENS			
J18	NOT USED			
J19	HOME POSSESSION	HOME BONUS 1	HOME BONUS 2	
J20	GUEST SCORE TENS	GUEST SCORE HUNDRED		
J21	GUEST TIME OUTS			
J22	PLAYER FOUL			
J23	GUEST FOULS TENS			
J24	HOME TIME OUTS			

### LED Driver Module Replacement

Electrical connections to the LDM1 LED DRIVER MODULE are made with ribbon cable polarized IDC sockets and locking ramp crimp terminal housings that mate with jacks on the module. The module is secured inside the scoreboard with four machine screws.

1. Unplug the electrical connections from the module. Do not cut the plastic tie wraps around the ribbon cables.
2. Remove the four screws.
3. Remove the module from the scoreboard.
4. Insert the replacement module in the scoreboard.
5. Secure the module with the four screws.
6. Insert the plugs into the jacks on the module.

**To avoid damage to the module, always turn off the power to the scoreboard when removing or replacing it.**

Figure 11 shows the location of the LPS-130VA Power Supply Module fuses and jack pins. The tables below figure 11 list their functions.

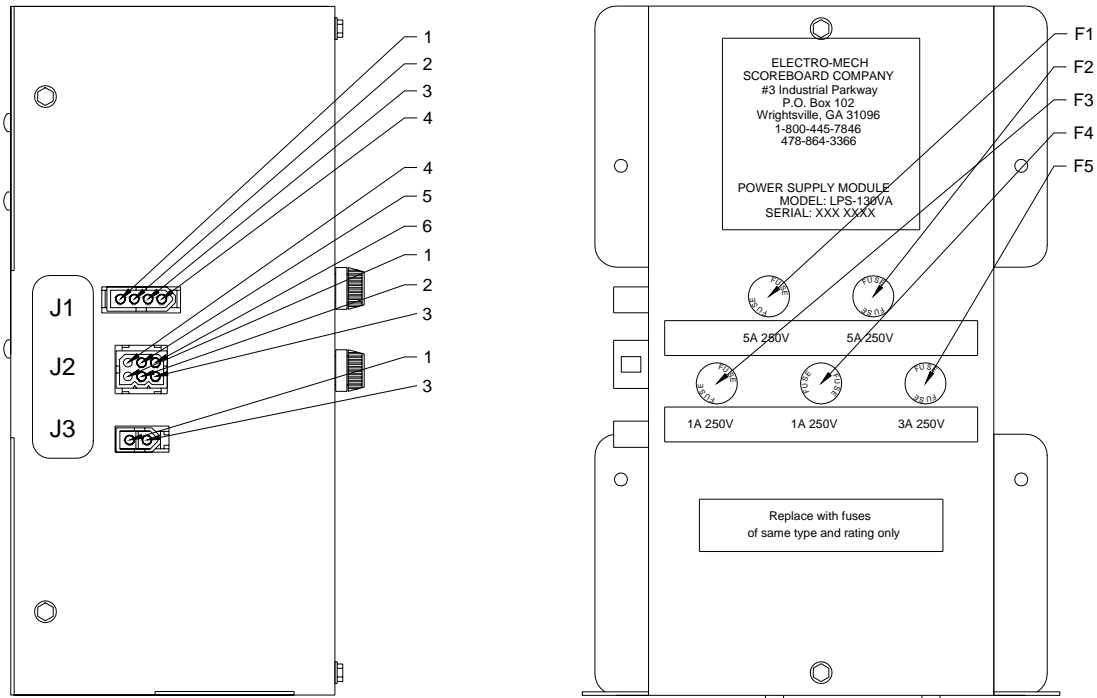

**Figure 11 LPS-130VA POWER SUPPLY MODULE**

#### LPS-130VA FUSES

FUSE	FUNCTION	BUSSMANN PART #
5A 250V	DRIVER MODULE DC POWER INPUT #1	AGC-5
5A 250V	DRIVER MODULE DC POWER INPUT #2	AGC-5
1A 250V	GOAL LIGHT RECEPTACLE	AGC-1
1A 250V	HORN	AGC-1
3A 250V	TRANSFORMER PRIMARY	AGC-3

Note: Other manufacturer's fuses may be substituted for the Bussmann fuses.

#### LED Power Supply Module Replacement

Electrical connections to the LED POWER SUPPLY MODULE LPS-130VA are made with three keyed plugs that mate with jacks on the left side of the module. The module is secured inside the scoreboard with two machine screws.

1. Disconnect the plugs from the three jacks on the module.
2. Remove the two machine screws.
3. Remove the module from the scoreboard.
4. Insert the replacement module in the scoreboard.
5. Secure the module with the four screws.
6. Insert the plugs into the jacks on the side of the module.

**To avoid damage to the module, always turn off the power to the scoreboard when removing or replacing it.**

## ELECTRO-MECH SCOREBOARD CO. FIVE YEAR LIMITED WARRANTY

THE ELECTRICAL COMPONENTS OF ALL ELECTRO-MECH SCOREBOARDS ARE GUARANTEED FOR A PERIOD OF FIVE (5) YEARS FROM THE DATE OF INVOICE AGAINST DEFECTS IN WORKMANSHIP OR MATERIAL AND WILL BE REPLACED OR REPAIRED WITHOUT COST TO THE OWNER PROVIDED THE EQUIPMENT OR PARTS ARE RETURNED POSTAGE-PAID TO THE FACTORY IN WRIGHTSVILLE, GA. SHIPPING BACK TO THE OWNER WILL BE VIA UPS GROUND SERVICE EXCEPT WHEN AIR OR SPECIAL METHOD OF RETURN IS SPECIFIED BY THE OWNER, IN WHICH CASE SHIPPING WILL BE FREIGHT COLLECT.

EXCLUDED FROM THIS WARRANTY ARE FUSES.

THIS WARRANTY DOES NOT INCLUDE LABOR CHARGES INCURRED IN THE REMOVAL OF COMPONENT PARTS, SERVICE CALLS, OR DAMAGES RESULTING FROM IMPROPER INSTALLATION, IMPROPER OPERATION, OR PROBLEMS CAUSED BY ANY REPAIR, ALTERATION OR MODIFICATION OF THE SCOREBOARD NOT PERFORMED BY ELECTRO-MECH.

EQUIPMENT WHICH IS SUBJECTED TO ACCIDENT, NEGLIGENCE, ABUSE, MISUSE OR OTHER NATURAL DISASTERS, INCLUDING BUT NOT LIMITED TO FIRE, WIND, LIGHTNING, OR FLOOD, IS NOT COVERED BY THIS GUARANTEE.