ELECTRO-MECH SCOREBOARD CO.

<i>BATTER</i>	<i>BALL</i>	<i>STRIKE</i>	<i>OUT</i>	<i>H</i>
30	3	1	2	E6

	1	2	3	4	5	6	7	8	9	10	<i>RUNS</i>	<i>HITS</i>	<i>ERRS</i>
<i>GUEST</i>	0	0	0	0	1	0	2	0	0	0	3	8	2
<i>HOME</i>	0	0	1	0	2	0	1	3	0	0	7	13	0

1750 BASEBALL SCOREBOARD

OWNER'S HANDBOOK

Thank you for choosing an Electro-Mech Scoreboard for your athletic complex. We are confident that your new scoreboard will give many years of reliable service.

Revised: 2020-March-11

TABLE OF CONTENTS

SCOREBOARD SPECIFICATIONS	3
SCOREBOARD INSTALLATION	4
MECHANICAL INSTALLATION	4
Post Installation	4
Mounting The Scoreboard.....	6
MOUNTING HARDWARE	6
Mounting The Optional Top Or Bottom ID Panel	8
ELECTRICAL INSTALLATION	8
Ground Connection	8
Power Connections	10
ScoreLink RF Modem System.....	11
Control Cable Installation	11
Control Console Connections	12
Control Console Safety Warning	12
SCOREBOARD OPERATION	13
SCOREBOARD STARTUP	13
GAME TIME OPERATION	13
Control Console Key Functions.....	15
SCOREBOARD SHUTDOWN	21
SERVICING THE SCOREBOARD.....	22
COMPONENT REPLACEMENT.....	22
LED Digits And Indicators Replacement.....	22
LX Driver Functions and Connections.....	25
LX Driver PCB Replacement	27
Power Supply Module Replacement.....	27
WARRANTY.....	28

SCOREBOARD SPECIFICATIONS

GENERAL: This ETL listed scoreboard includes the scoreboard cabinet, mounting hardware, control console, 10 ft. extension cable, and junction box.

DIMENSIONS: 26 ft. L x 9 ft. H x 6 in. D

WEIGHT: 800 lbs. (Top cabinet 300 lbs.; bottom cabinet 500 lbs.)

SCOREBOARD CONSTRUCTION: The outer frame is made from extruded aluminum. Internal structural parts may be extruded aluminum or formed from aluminum sheet. The face and back are made from aluminum sheet. The face and masks are finished with enamel paint. Black is the standard color. The captions and optional accent striping are vinyl.

DISPLAY: The 1750 baseball scoreboard displays Inning-by-Inning Runs to 9 for each of ten Innings, Total Runs to 99, Total Hits to 99, and Total Errors to 9 for the Guest Team along with an identical row of Inning-by-Inning Runs and Totals for the Home Team. Fielder Position, Ball, Strike, and Out counts are displayed with full digits. Flashing "H" and "E" characters indicate Hits and Errors. Batter Number shows the player at bat from 0 to 99.

DIGITS AND INDICATORS: Red or amber light emitting diodes mounted on printed circuit boards form the digits and indicators. Batter Number, Ball, Strike, and Out digits are 18 inches tall. All other digits and characters are 15 inches tall.

POWER REQUIREMENTS: **Scoreboard** - 120 VAC, 5.3 A, 60 Hz
Control Console - 120 VAC, 0.5 A, 60 Hz

SCOREBOARD ELECTRONICS: 100% solid state fully enclosed.

CONTROL CONSOLE: The control console features a microprocessor, 37-key sealed membrane keypad, an LCD display, and an attached 6-foot power cord. The console housing consists of ABS plastic base and top pieces with a steel back plate.

CONTROL CABLE: The cable has two 22 AWG stranded copper conductors with semi-rigid PVC insulation. It also has a braided shield and a foil shield. The polyethylene jacket is rated at 300 volts. The cable is direct burial rated and measures approximately 1/4-inch in diameter. This item is sold separately from the scoreboard.

JUNCTION BOX AND EXTENSION CABLE: A 4-1/4-inch x 2-1/4-inch x 2-inch junction box with a 1/4-inch stereo jack mounted on the face plate is attached to the control cable at the point of operation. A 10-foot extension cable connects the control console to the junction box.

SCORELINK RF MODEM SYSTEM: This accessory can be used in place of the control cable and junction box for this scoreboard without internal modifications to the scoreboard or the control console. Refer to the SCORELINK RF MODEM SYSTEM OWNER'S HANDBOOK for more information.

WARRANTY: Five-year limited warranty.

SCOREBOARD INSTALLATION

This part of the manual describes the mechanical and electrical installation of the scoreboard.

One of the items listed below must be purchased in order to complete the installation:

- Control cable (length dependent upon installation site layout)
- ScoreLink RF Modem System

Items not provided by Electro-Mech Scoreboard Company that are necessary for installation:

- Three posts (Additional posts may be needed if an alternate configuration is specified.)
- Power cable to connect the scoreboard to the power source
- Grounding hardware
- A grounded NEMA 5-15R 120 VAC receptacle for the control console at the scorekeeper's table.

Items not provided that are recommended by Electro-Mech Scoreboard Company for installation:

- A weatherproof power disconnect at the scoreboard

Electro-Mech Scoreboard Company performs installations in some areas. In other areas, we can help you contact an independent installer. In areas in which installation service is not available from Electro-Mech Scoreboard Company, we will make every effort to answer your installation questions. Qualified personnel should perform the scoreboard installation. Consult national and local codes before installation.

MECHANICAL INSTALLATION

The mechanical installation includes installing the posts and mounting the scoreboard and the optional ID panels (if purchased) to the posts.

Post Installation

The scoreboard, in its standard configuration, mounts on three posts. Typically installers will use steel pipes or I-beams. In order to reduce the glare from the sun on the front of the scoreboard, position the posts so that the front of the scoreboard is angled away from the afternoon sun, if possible. The mounting hardware will accommodate posts up to 7 inches outer diameter. Sink the posts in reinforced concrete footings. Figure 1 shows the spacing of the posts for a Model 1750 scoreboard. The specifications for the posts and concrete footings are dependent upon the expected local wind and soil conditions, the height of the scoreboard from the ground, and the local building codes. Electro-Mech Scoreboard Company assumes no responsibility for the installation of scoreboards by others.

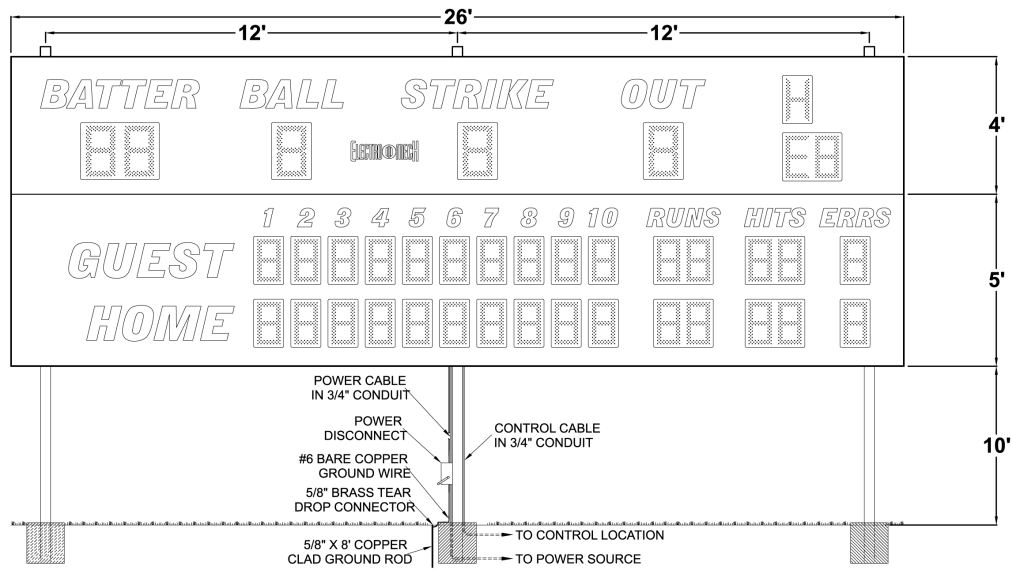

Figure 1 Model 1750 Post Spacing

Figure 2 shows the spacing of the posts for a Model 1750 scoreboard with an optional top ID panel. This panel is a separate unit that mounts on the same posts as the scoreboard.

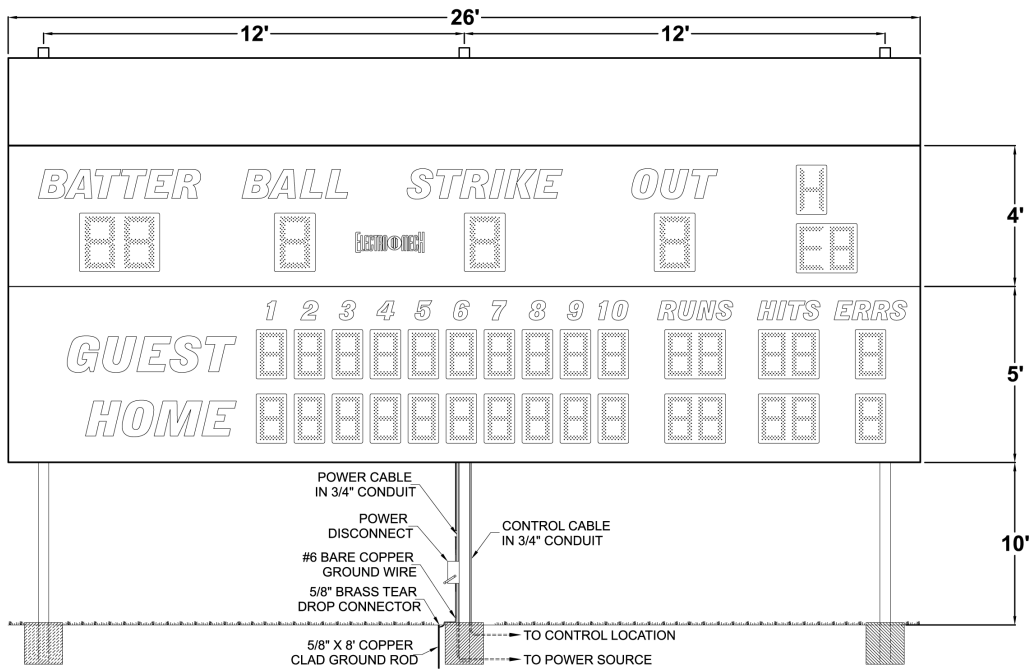

Figure 2 Model 1750 with Top ID Panel Post Spacing

Mounting The Scoreboard

The scoreboard is attached to the posts at four points. Figure 3 shows the location of the mounting points on the rear of the scoreboard.

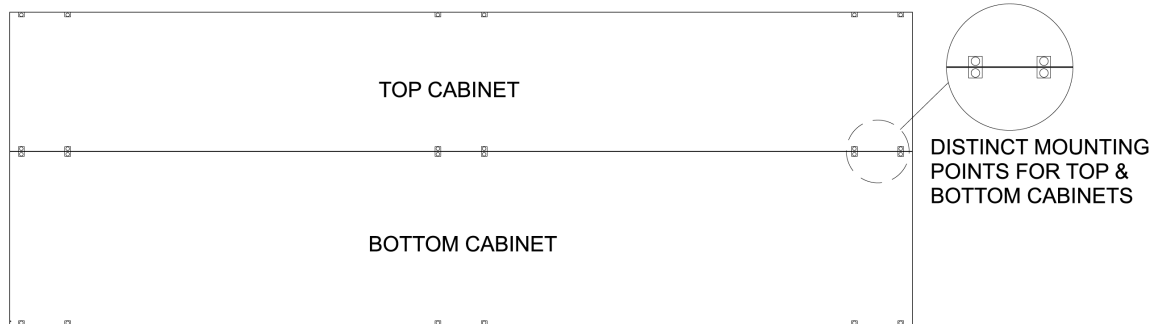

Figure 3 Mounting Points

MOUNTING HARDWARE

Twelve sets of mounting hardware are provided to attach the scoreboard at these points. Additional hardware sets are provided to attach the optional ID panels, if ordered. A single set of mounting hardware consists of a steel angle bracket, two threaded rods, two washers, and two nuts. Figure 4 shows an overhead cross section view and a side cross section view of the scoreboard attached to a post at a mounting point. A steel bar is riveted inside the scoreboard's aluminum extrusion frame. The bar has two tapped holes. The threaded rods screw into these tapped holes. The washers and nuts are used to clamp the steel angle bracket against the steel post and hold the scoreboard in place.

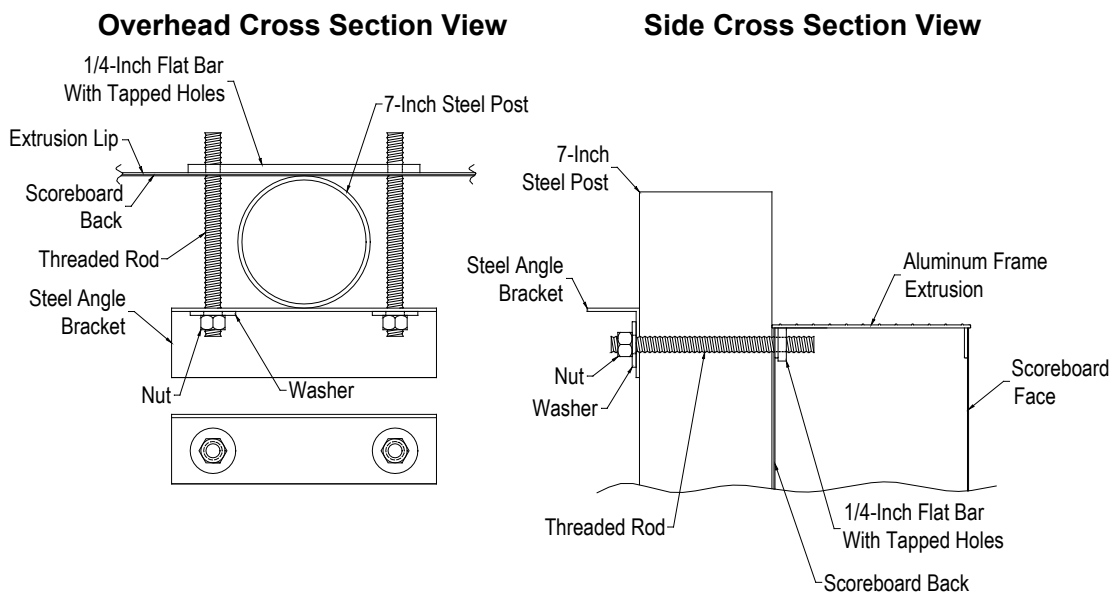

Figure 4 Standard Mounting Method

The following steps describe how to mount the scoreboard on the posts:

1. Place the scoreboard cabinet against the posts on the ground. Make sure the mounting points are aligned with the posts.
2. Screw the threaded rods into the tapped holes in the scoreboard.
3. Place a steel angle bracket over the threaded rods at a mounting point.
4. Place a washer over each threaded rod.
5. Screw the nuts onto the threaded rods so that the bracket is loosely held in place.
6. Repeat steps 2 - 5 at the other mounting points.
7. Raise the scoreboard into place and tighten the nuts to clamp the scoreboard in place on the posts.

Note: Be sure to leave enough space on the posts above the scoreboard for the optional top or bottom ID panel(s), if purchased.

Mounting The Optional Top Or Bottom ID Panel

Additional hardware sets are provided to attach any optional top or bottom ID panels, if purchased. The following steps describe how to mount an ID panel on the posts:

1. Raise the ID panel in place above or below the scoreboard. Make sure the mounting points are aligned with the posts.
2. Screw the threaded rods into the tapped holes in the ID panel.
3. Place a steel angle bracket over the threaded rods at a mounting point.
4. Place a washer over each threaded rod.
5. Screw a nut onto each threaded rod so that the bracket is loosely held in place.
6. Repeat steps 2 - 5 at the other mounting points.
7. Tighten the nuts to clamp the ID panel in place on the posts.

ELECTRICAL INSTALLATION

We recommend a qualified electrician perform the needed electrical connections to ensure proper operation of the scoreboard. These connections include grounding the scoreboard, connecting the scoreboard to a power source, installing the ScoreLink RF Receiver or the control cable, and connecting the control console.

Ground Connection

The National Electrical Code **requires** a scoreboard (electric sign) to be grounded. Grounding the scoreboard helps the scoreboard electronics operate properly and helps minimize damage if it is struck by lightning. Metal posts do **not** provide an adequate ground path. The following steps describe how to ground the scoreboard:

1. Drive one or more 5/8-inch x 8-foot copper clad ground rods in the soil near the scoreboard.
2. Connect #6 bare copper wire to the ground rods using 5/8-inch brass tear drop connectors.
3. Remove the rear access panel and the dome plugs on the plate near the access panel. Figure 5 shows the location of the access panel and the dome plugs.
4. Pass the ground conductor through the one of the knockouts in the plate near the access panel and connect it to the ground lug (**Ground**) on the chassis.

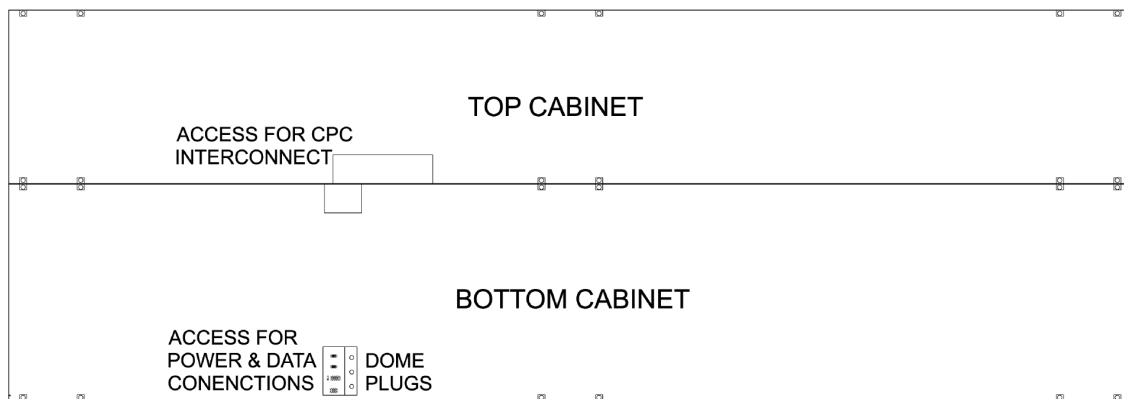

Figure 5 Rear Access Panel

Power Connections

The scoreboard requires 120 VAC, 60 Hz service at the scoreboard to operate properly. **Maximum power consumption of Model 1750: 660 Watts.** Make sure the power cable is rated for this electrical load. Install the power cable in conduit. **Avoid** running the power cable in close proximity to the control cable. The following steps describe how to connect the scoreboard to the power source:

1. Feed the power cable through one of the knockouts in the plate near the access panel.
2. Crimp fork terminals to the power cable wires.
3. Connect the AC line wire and AC neutral wire to the **Main Power** terminal block on the chassis according to figure 6.

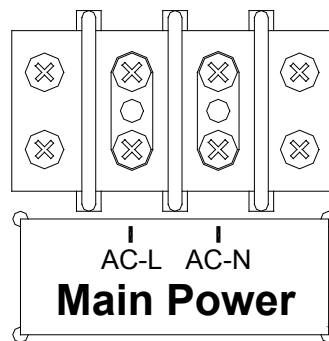

Figure 6 Power Connections

Install a power disconnect that isolates all current carrying conductors (not the ground conductor) on one of the posts below the scoreboard. If a secondary switch is installed near the scorekeeper's table, it should also isolate these conductors. Place the power disconnect in the **OFF** position between games to help protect the scoreboard from lightning damage. A power disconnect on the scoreboard post also provides a convenient way of turning the scoreboard off during maintenance or repairs.

ScoreLink RF Modem System

The SCORELINK RF MODEM SYSTEM is designed to eliminate the control cable between the scoreboard and the control console on Electro-Mech Scoreboard LED scoreboards. If you have purchased this accessory, disregard the section of this manual titled **Control Cable Installation**. Refer to the installation manual provided for this product.

Control Cable Installation

The control cable connects the scoreboard to the control console. Install the control cable in conduit. If the cable is ever damaged, it is easier and less expensive to replace a cable in conduit. A small junction box with a 1/4-inch stereo jack mounted on the face plate is attached to the control cable at the point of operation of the scoreboard. This junction box should be securely mounted in a clean, dry area within ten feet of the rear of the control console. Most customers order the control cable with the junction box attached. Some customers prefer to attach the junction box after the cable is installed. Those customers must solder the control cable to the 1/4-inch stereo jack. Figure 7 shows the control cable wire connection points on the rear of the 1/4-inch stereo jack.

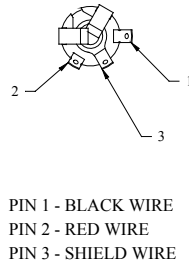

Figure 7 1/4-inch Stereo Jack Wiring Diagram

The following steps describe how to connect the control cable to the scoreboard:

1. At the rear of the scoreboard feed the control cable through one of the knockouts.
2. Crimp fork terminals to the control cable wires and the shield.
3. Connect the control cable to the **Control Cable** terminal block on the chassis according to Figure 8.

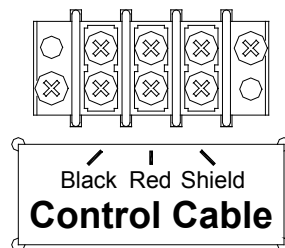

Figure 8 Control Cable Wiring Diagram

4. Reinstall the access panel.

Control Console Connections

The 10 ft. extension cable has two molded 1/4-inch stereo plugs attached to it. It is used to connect the control console to the junction box. The following steps describe how to connect the control console:

1. Plug one end of the extension cable into 1/4-inch stereo jack on the junction box.
2. Plug the other end into the 1/4-inch stereo jack mounted on the control console back plate.
3. Plug the control console power cord into a grounded NEMA 5-15R 120 VAC receptacle.

Control Console Safety Warning

This product is equipped with a 3-wire grounding type plug, a plug having a third (grounding) pin. This plug will only fit into a grounding-type power outlet. This is a safety feature. If you are unable to insert the plug into the outlet, contact a qualified electrician to replace your obsolete outlet. Do not defeat the purpose of the grounding-type plug.

SCOREBOARD OPERATION

SCOREBOARD STARTUP

1. Place the power disconnect for the scoreboard in the **ON** position.
2. Plug one end of the extension cable into 1/4-inch stereo jack on the junction box.
3. Plug the other end into the 1/4-inch stereo jack mounted on the control console back plate.
4. Plug the control console power cord into a grounded NEMA 5-15R 120 VAC receptacle.

GAME TIME OPERATION

This scoreboard is operated with a 37-key control console. Figure 9 shows the keypad layout on the control console.

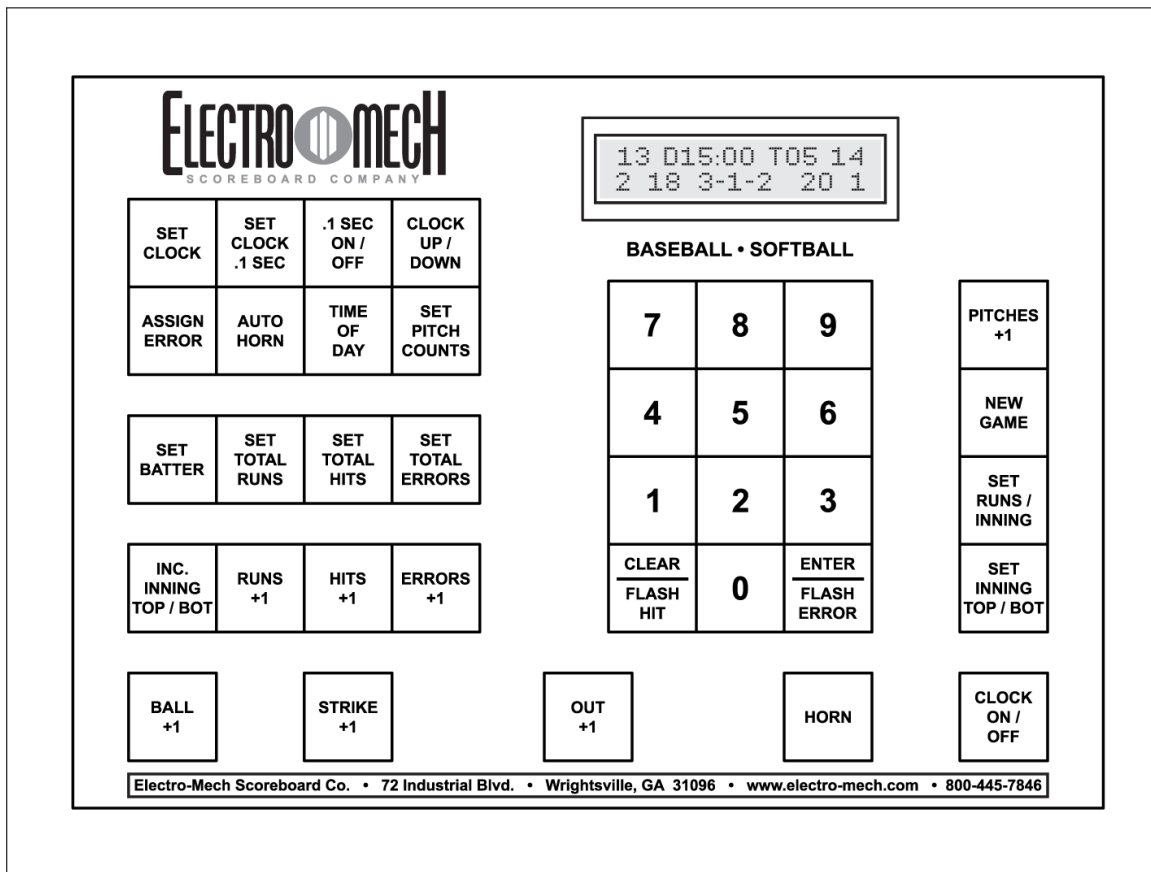

Figure 9 Keypad Layout

Immediately after the control console power cord is plugged into a 120 VAC source, the console LCD display will read:

```
ELECTRO-MECH 314
LINESCORE5 0000
```

After a few seconds the display will read:

```
00 D15:00 B- 00
0 00 0-0-0 00 0
```

The scoreboard will display:

Guest Total Runs, Hits, and Errors: 0

Home Total Runs, Hits, and Errors: 0

Batter Number: 0

All other functions will be blank

The control console LCD display shows the total runs for the Guest and Home teams along with a 4-digit Game Clock (or a 3-digit Game Clock for times greater than one hour), Inning, Guest and Home Pitches, and Ball-Strike-Out counts. It also provides instructions to help the operator use some of the console functions. Figure 10 explains the LCD display layout.

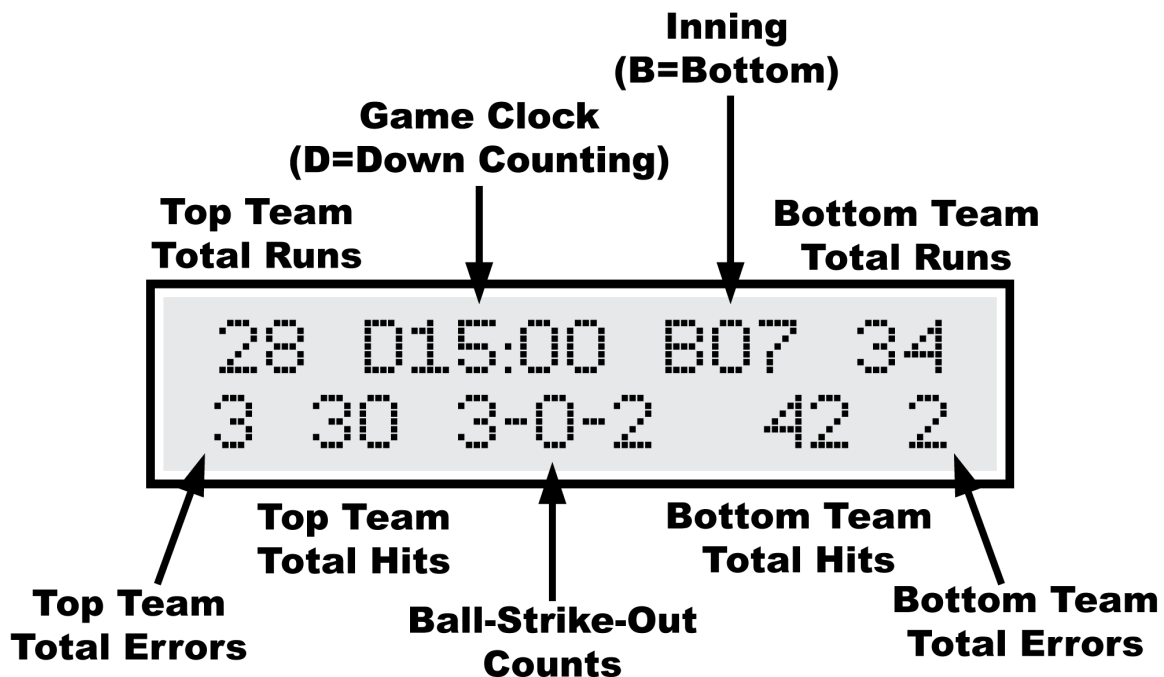

Figure 10 Control Console LCD Display

Control Console Key Functions

Many keys discussed below control features and options not displayed on the Model 1750 scoreboard. For instance, Model 1750 has no Clock display or Horn.

1. **SET CLOCK** – This key allows the operator to edit or set the Game Clock to any time from 0:00 to 9:59:59. The LCD display prompts with the current time. Pressing [ENTER] accepts whatever time value is showing in the lower right prompt area of the LCD. Use the numeric keypad to enter a new time value. For instance, to set the Game Clock to 45:00, first press [SET CLOCK].

```
00 D15:00 B- 00
SET CLK<0:15:00>
```

Press [4] [5] [0] [0] [ENTER] to complete the process.

2. **SET CLOCK .1 SEC** – During the final minute of a count-down period, the Game Clock can show Seconds and Tenths of Seconds (SS.t) instead of Minutes and Seconds (MM:SS). Use this key to adjust the time including the Seconds Tenths. To set the time to 29.9 seconds, press [SET CLOCK .1 SEC].

```
00 D15:00 B- 00
SET SEC <00.0>
```

Press [2] [9] [9] [ENTER] to complete the process.

3. **.1 SEC ON / OFF** – By default, your console enters Tenth of Second Mode at the end of a count down period. This means the display on the scoreboard (and the LCD on the console) shifts from showing Minutes and Seconds (MM:SS) to showing Seconds and Tenths of Seconds (SS.t). You can stop this behavior (or restart it) with this key. Press [.1 SEC ON / OFF].

```
1/10TH SECOND
1=YES 0=NO <1>
```

Press [0] [ENTER] to turn off Tenth of Second Mode.

4. **CLOCK UP/DOWN** – Your console can count time up or down. The default Game Clock direction is down-counting. To switch to an up-counting Game Clock, press the [CLOCK UP/DOWN] key.

```
COUNT UP OR DOWN
1=UP 0=DOWN <0>
```

Press [1] [ENTER] to select the up-counting Game Clock.

5. **ASSIGN ERROR** – This key allows you display the Position of a Fielder who commits an Error. To assign an Error to the left fielder (Position 7), press [ASSIGN ERROR].

```
00 D15:00 B- 00
ERR POSITION <0>
```

Press [7] [ENTER] flash a "7" on the scoreboard. The "E" character will also flash.

6. **AUTO HORN** – This key allows you to control whether or not the Horn sounds automatically at the end of a period. By default the Horn sounds whenever the Game Clock counts down to 0:00. To disable this behavior, first press [AUTO HORN].

```
AT END OF PERIOD
1=AUTO 0=OFF <1>
```

Press [0] [ENTER] to stop the automatic horn function.

7. **TIME OF DAY** – This key allows you to set and display the Time of Day on the Game Clock of the scoreboard. You also have the option of leaving the rest of the scoreboard (other than the Clock) available for displaying game information or blanking all those features so that only the Clock is displayed.

```
TIME OF DAY CLCK
1=YES 0=NO <0>
```

Press [1] [ENTER] to continue into the Time of Day function. Next you have the option to turn off all other functions on the scoreboard:

```
BLANK OTHERS?
1=YES 0=NO <0>
```

Press [0] [ENTER] if you want to continue to use the other features of the scoreboard. Finally, you are promoted to enter the current time.

```
00 D15:00 B- 00
SET CLK <12:05>
```

Press [5] [3] [7] [ENTER] to set the clock to 5:37. The letter "C" appears on the LCD display to the left of the time to indicate you are using the Time of Day Clock.

8. **SET PITCH COUNT** – This key allows you to edit or set Pitch Counts for the Guest and Home teams. The LCD prompts you for Pitch Count of the team playing in the top half of each Inning first, and then prompts you for the other team's Pitch Count.

```
00 D15:00 B- 00
PCH CNT TOP<000>
```

Press [1] [0] [0] [ENTER] to set the first team's Pitch Count to 100.

```
00 D15:00 B- 00
PCH CNT BOT<000>
```

Press [0] [ENTER] to set the second team's Pitch Count to 0.

9. **SET BATTER** – This key allows you display the number of the player currently at bat To show player number 12, press [SET BATTER].

```
00 D15:00 B- 00
BATTER NUM <00>
```

Press [1] [2] [ENTER] to complete the process.

10. **SET TOTAL RUNS** – Set or edit the Total Runs for each team. In the example below, the Guest Team (Top) has 6 Runs showing and the Home Team (Bottom) has 8 Runs showing. Let's edit them to 5 and 9 respectively. Press [SET TOTAL HITS].

```
06 D15:00 B05 08
TOT RUNS TOP<06>
```

Press [5] [ENTER] to set the Guest/Top Runs to 5.

```
06 D15:00 B05 08
TOT RUNS BOT<08>
```

Press [9] [ENTER] to set the Home/Bottom Runs to 9.

11. **SET TOTAL HITS** – Set or edit the Total Hits for each team. Works pretty much like [SET TOTAL RUNS].
12. **SET TOTAL ERRORS** – Set or edit the Total Errors for each team. Works pretty much like [SET TOTAL RUNS].
13. **INC. INNING T / B** – This key moves to the next half inning.

14. **RUNS +1** – This key will increment the Runs for the team currently At Bat. On the scoreboard, this information is updated both on the Total Runs display and on the Runs-By-Inning display for the current Half Inning. For instance, if it is the Bottom of the 5th Inning, pressing this key will cause the Runs showing for the Home Team in the 5th Inning column to increment along with the Total Runs for the Home Team.
15. **HITS +1** – This key will increment the Total Hits for the team currently At Bat.
16. **ERRORS +1** – This key will increment Total Errors for the team currently not At Bat.
17. **BALLS +1** – This key will increment the Ball Count by 1.
18. **STRIKES +1** – This key will increment the Strike Count by 1.
19. **OUTS +1** – This key will increment the Out Count by 1.
20. **HORN ON/OFF** - This key allows you to manually sound the Horn for scoreboards with that option installed.
21. **CLEAR / FLASH HIT** – This key has two purposes. It can be used to clear incorrect keypad entries. It can also be used to flash the Hit indicator.
22. **ENTER / FLASH ERROR** – This key has two purposes. It is used to complete the entry of data. It can also be used to flash the Error indicator.
23. **CLOCK ON / OFF** - Use this key to start and stop the Game Clock.
24. **PITCH COUNT +1** – This key will increment the Pitch Count for the team currently not At Bat.

25. **SET RUNS / INNINNG** - Set or edit the Runs-By-Inning for a particular Inning. For instance, to change the number of Runs showing in the Bottom of the 4th Inning from 2 to 3, press [SET RUNS / INNING].

```
06 D15:00 B05 08
EDIT INNING <05>
```

Press [4] [ENTER] work on the 4th Inning.

```
06 D15:00 B05 08
SET RUNS TOP <1>
```

We are not interested in the Top Half of the Inning in this example, so press [ENTER] to continue to the next prompt without changing the value.

```
06 D15:00 B05 08
SET RUNS BOT <2>
```

Press [3] [ENTER] to finish. Note that the Total Runs function does not recalculate based on the new value. You must use the [SET TOTAL RUNS] button to make everything add up properly.

26. **SET INNINNG T / B** - Set current Half Inning. For instance, to set the console to work in the Top of the 3rd Inning, press [SET INNING T / B].

```
06 D15:00 B05 08
SET INNING <05>
```

Press [3] [ENTER] to select the 3rd Inning.

```
06 D15:00 B05 08
1=TOP 0=BOT <1>
```

Press [1] [ENTER] select the Top Half.

27. **NEW GAME** - This key has the primary function of allowing the control console operator to clear information from the previous game and start fresh. You should do this at the beginning of every game. Press [NEW GAME].

RESET	SCOREBOARD
1=YES	0=NO <0>

Press [1] [ENTER] to clear the game memory.

There are several sub-functions available via the New Game menu...

- Press [NEW GAME] [4] to blank everything on the scoreboard. Please remember that this is a diagnostic feature to allow you to test for LEDs that are staying illuminated when they should not; this is not a method for turning off power to the scoreboard.
- Press [NEW GAME] [5] to enter Lamp Test Mode, which turns on all LEDs on the scoreboard.
- Press [NEW GAME] [8] to enter Precision Time Mode. This feature allows for an alternate method of starting and stopping the Game Clock. Hardware requiring this feature includes instructions for using it. Unless you have accessories that require this feature, it is not of any real value. Note that when you are in Precision Time mode, the [CLOCK START / STOP] key does not do anything, and the LCD display shows a "P" in front of the Clock:

06	P15:00	B05	08
4	12	1-2-0	15 2

You should reset the scoreboard each time that it is turned on. Test out all the functions to ensure that the scoreboard is operating properly.

SCOREBOARD SHUTDOWN

1. Place the power disconnect for the scoreboard in the **OFF** position.
2. Unplug the control console power cord.
3. Unplug the extension cable.
4. Store the control console in a dry location. This unit is not waterproof.

Proper scoreboard shutdown will help protect the scoreboard and control console from power surges and lightning strikes.

SERVICING THE SCOREBOARD

While your scoreboard was designed for years of trouble-free operation, some problems may occasionally occur. Electro-Mech Scoreboard Company offers onsite service in some areas. In other areas, we can help you contact an independent service technician. In areas in which service is not available from Electro-Mech Scoreboard Company, we will make every effort to answer your questions. Our trained personnel at Electro-Mech Scoreboard Company are ready to answer your questions from Monday to Friday during the hours of 8 AM to 5 PM Eastern Standard Time. Be sure to know your scoreboard model number when calling. Scoreboard replacement parts are always available. Damaged parts can usually be repaired at a significant cost savings. Our convenient toll free number is listed at the bottom of every page in this manual.

If the scoreboard turns on LEDs, but does not operate normally, make note of which functions are affected. If some LEDs either never turn on or always stay on, make note of their specific locations on the scoreboard. Refer to the COMPONENT REPLACEMENT section of this manual before changing parts.

COMPONENT REPLACEMENT

LED digits and indicators are serviced from the front of the scoreboard.

LED Digits And Indicators Replacement

The LEDs that form digits and indicators are soldered on circuit boards mounted behind metal masks. Do not attempt to replace individual LEDs. In case of a malfunction, the entire LED circuit board must be removed. **To avoid damage to the LED driver PCB, always turn off the power to the scoreboard when removing or replacing LED digits and indicators.** Figure 11 shows the components of a LED digit assembly. LED indicator assemblies are similar in construction.

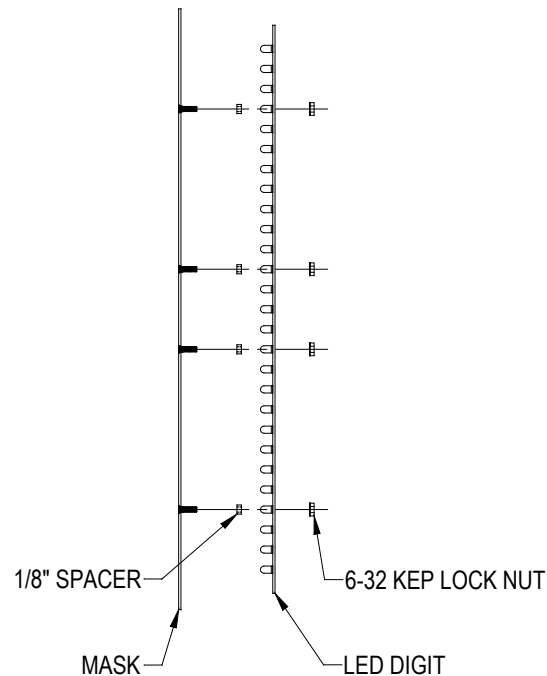
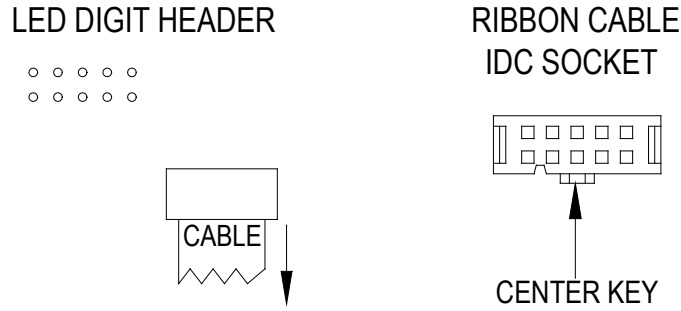

Figure 11 LED Digit Assembly

The following steps describe how to replace a defective LED digit:

1. Remove the sheet metal screws that fasten the mask to the face of the scoreboard.
Caution: Support the mask with your hand before removing the last screw. The ribbon cable that connects to the rear of the circuit board is not designed to support the weight of the assembly.
2. Disconnect the ribbon cable from the rear of the circuit board. For assemblies with two LED digits, it will be necessary to disconnect the ribbon cables from both circuit boards. The cables are labeled to indicate the proper circuit board connection.
Caution: Do not let the cable hang outside of the scoreboard. It is easily cut by sharp metal edges. Damage to the ribbon cable may create short circuit paths that will damage the LED driver PCB.
3. Place the assembly on a flat surface and remove the 6-32 kep lock nuts that hold the defective circuit board in place.
4. Remove the circuit board from the assembly.
5. Align the mounting holes in the replacement LED digit circuit board with the threaded studs on the mask and install it on the mask using the 6-32 kep lock nuts.
6. Plug the ribbon cable onto the header on the back of the circuit board. Refer to figure 12 in order to plug the ribbon cable IDC connector onto the circuit board in the proper orientation.



CENTER KEY ON RIBBON CABLE IDC SOCKET
MUST POINT IN THE SAME DIRECTION AS THE
ARROW ON THE REAR OF THE LED DIGIT.

Figure 12 LED Digit Ribbon Cable Connection Diagram

7. Reinstall the assembly using the sheet metal screws.

All power and driver logic components are located behind the Guest and Home Total Runs Digits and the Out digit. Figure 13 shows the components with the digit mask removed.

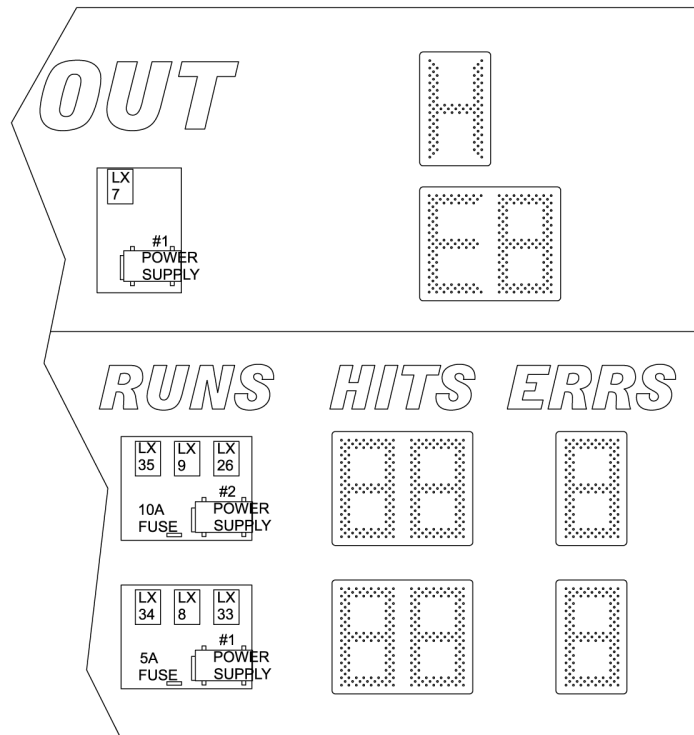

Figure 13 Component Locations

LX Driver Functions and Connections

LX DRIVER PCBs USED IN MODEL 1750	
LX DRIVER	FUNCTIONS CONTROLLED
LX34	Bottom/Home Runs-By-Inning 1, 2, 3, 4, 5, and 6
LX8	Bottom/Home Runs-By-Inning 7, 8, and 9
LX33	Bottom/Home Total Runs
LX35	Top/Guest Runs-By-Inning 1, 2, 3, 4, 5, and 6
LX9	Top/Guest Runs-By-Inning 7, 8, and 9
LX26	Top/Guest Total Runs
LX7	Ball, Strike, Out, Batter Number, "H", "E", Err Fielder

LX34 CONNECTORS USED	
PCB JACK	FUNCTION
J3	Output Data
J4	Bottom/Home Runs-By-Inning 1
J5	Bottom/Home Runs-By-Inning 2
J6	Bottom/Home Runs-By-Inning 3
J7	DC Power Input
J8	Bottom/Home Runs-By-Inning 5
J9	Bottom/Home Runs-By-Inning 4
J10	Bottom/Home Runs-By-Inning 6
SHLD, RED, BLK	Input Data

LX8 CONNECTORS USED	
PCB JACK	FUNCTION
J3	Output Data
J4	Bottom/Home Runs-By-Inning 7
J5	Bottom/Home Runs-By-Inning 8
J6	Bottom/Home Runs-By-Inning 9
J7	DC Power Input
SHLD, RED, BLK	Input Data

LX33 CONNECTORS USED	
PCB JACK	FUNCTION
J3	Output Data
J4	Bottom/Home Total Runs Units
J5	Bottom/Home Total Runs Tens
J7	DC Power Input
SHLD, RED, BLK	Input Data

LX35 CONNECTORS USED	
PCB JACK	FUNCTION
J3	Output Data
J4	Top/Guest Runs-By-Inning 1
J5	Top/Guest Runs-By-Inning 2
J6	Top/Guest Runs-By-Inning 3
J7	DC Power Input
J8	Top/Guest Runs-By-Inning 5
J9	Top/Guest Runs-By-Inning 4
J10	Top/Guest Runs-By-Inning 6
SHLD, RED, BLK	Input Data

LX9 CONNECTORS USED	
PCB JACK	FUNCTION
J3	Output Data
J4	Top/Guest Runs-By-Inning 7
J5	Top/Guest Runs-By-Inning 8
J6	Top/Guest Runs-By-Inning 9
J7	DC Power Input
SHLD, RED, BLK	Input Data

LX26 CONNECTORS USED	
PCB JACK	FUNCTION
J3	Output Data
J4	Top/Guest Total Runs Units
J5	Top/Guest Total Runs Tens
J7	DC Power Input
SHLD, RED, BLK	Input Data

LX7 CONNECTORS USED	
PCB JACK	FUNCTION
J3	Output Data
J4	Batter Number Units, "H"
J5	Batter Number Tens
J6	Ball Digit, "E"
J7	DC Power Input
J8	Out Digit
J9	Strike Digit
J10	Error Fielder Position
SHLD, RED, BLK	Input Data

LX Driver PCB Replacement

Electrical connections to the LX Driver Printed Circuit Boards are made with ribbon cable polarized IDC sockets and locking ramp crimp terminal housings that mate with jacks on the PCB. Four machine screws are used to secure a LX Driver PCB inside the scoreboard.

1. Unplug the electrical connections from the PCB. Do not cut the plastic tie wraps around the ribbon cables.
2. Remove the four screws.
3. Remove the PCB from the scoreboard.
4. Insert the replacement PCB in the scoreboard.
5. Secure the PCB with the four screws.
6. Insert the plugs into the jacks on the module.

To avoid damage to the PCB, always turn off the power to the scoreboard when removing or replacing it.

LED Power Supply Module Replacement

The Model 1750 uses a Mean Well SP-320-24 power supply module. Replacement modules are available from Electro-Mech or through distributors of Mean Well power supplies. The power supply must be set to provide 18.9 VDC output, which is how they are configured when shipped from Electro-Mech. Connections are made to a set of screw terminals along the left side of the power supply as illustrated below:

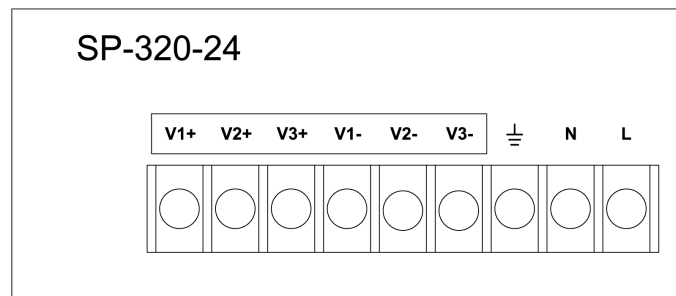

Figure 14 Power Module Screw Terminals

To avoid damage to the power supply module, always turn off the power to the scoreboard when removing or replacing it.

A fuse holder is mounted to the left of each power supply and connected inline with the incoming 120 VAC line side of the power running from the Main Power terminal strip to the Mean Well SP-320 power supply module. The fuses are 10 amp 250 volt 3AG style fuses and should only be replaced with fuses of that type.

ELECTRO-MECH SCOREBOARD CO. FIVE YEAR LIMITED WARRANTY

THE ELECTRICAL COMPONENTS OF ALL ELECTRO-MECH SCOREBOARDS ARE GUARANTEED FOR A PERIOD OF FIVE (5) YEARS FROM THE DATE OF INVOICE AGAINST DEFECTS IN WORKMANSHIP OR MATERIAL AND WILL BE REPLACED OR REPAIRED WITHOUT COST TO THE OWNER PROVIDED THE EQUIPMENT OR PARTS ARE RETURNED POSTAGE-PAID TO THE FACTORY IN WRIGHTSVILLE, GA. SHIPPING BACK TO THE OWNER WILL BE VIA UPS GROUND SERVICE EXCEPT WHEN AIR OR SPECIAL METHOD OF RETURN IS SPECIFIED BY THE OWNER, IN WHICH CASE SHIPPING WILL BE FREIGHT COLLECT.

EXCLUDED FROM THIS WARRANTY ARE FUSES.

THIS WARRANTY DOES NOT INCLUDE LABOR CHARGES INCURRED IN THE REMOVAL OF COMPONENT PARTS, SERVICE CALLS, OR DAMAGES RESULTING FROM IMPROPER INSTALLATION, IMPROPER OPERATION, OR PROBLEMS CAUSED BY ANY REPAIR, ALTERATION OR MODIFICATION OF THE SCOREBOARD NOT PERFORMED BY ELECTRO-MECH.

EQUIPMENT WHICH IS SUBJECTED TO ACCIDENT, NEGLIGENCE, ABUSE, MISUSE OR OTHER NATURAL DISASTERS, INCLUDING BUT NOT LIMITED TO FIRE, WIND, LIGHTNING, OR FLOOD, IS NOT COVERED BY THIS GUARANTEE.