

ELECTRO-MECH SCOREBOARD CO.

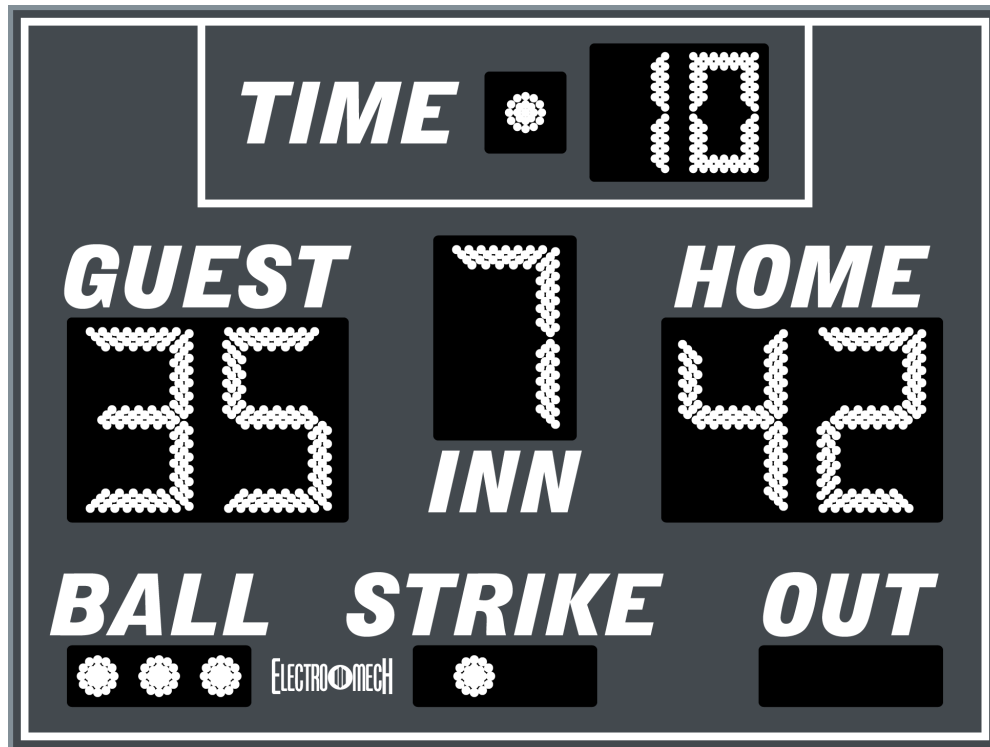

1136 BASEBALL SCOREBOARD

OWNER'S HANDBOOK

Thank you for choosing an Electro-Mech Scoreboard for your athletic complex. We are confident that your new scoreboard will give many years of reliable service.

Revised: 2010-May-12

TABLE OF CONTENTS

SCOREBOARD SPECIFICATIONS	3
SCOREBOARD INSTALLATION	4
MECHANICAL INSTALLATION	4
Post Installation	4
Mounting The Scoreboard.....	6
MOUNTING HARDWARE	6
Mounting The Optional Top Or Bottom ID Panel	8
ELECTRICAL INSTALLATION	8
Ground Connection	8
Power Connections	10
ScoreLink RF Modem System.....	11
Control Cable Installation	11
Control Console Connections	12
Control Console Safety Warning	12
SCOREBOARD OPERATION	13
SCOREBOARD STARTUP	13
GAME TIME OPERATION	13
Control Console Key Functions.....	15
SCOREBOARD SHUTDOWN	18
SERVICING THE SCOREBOARD.....	19
COMPONENT REPLACEMENT.....	19
LED Digits And Indicators Replacement.....	19
LX Driver Functions and Connections.....	22
LX Driver PCB Replacement	23
Power Supply Module Replacement.....	23
WARRANTY.....	24

SCOREBOARD SPECIFICATIONS

GENERAL: This ETL listed scoreboard includes the scoreboard cabinet, mounting hardware, control console, 10 ft. extension cable, and junction box.

DIMENSIONS: 8 ft. L x 6 ft. H x 6 in. D

WEIGHT: 200 lbs

SCOREBOARD CONSTRUCTION: The outer frame is made from extruded aluminum. Internal structural parts may be extruded aluminum or formed from aluminum sheet. The face and back are made from aluminum sheet. The face and masks are finished with enamel paint. Black is the standard color. The captions and optional accent striping are vinyl.

DISPLAY: The 1136 baseball scoreboard displays Home and Guest Scores to 99, Inning to 9, indicators for Ball, Strike, Out, and a Game Clock showing Minutes to 90; during the final minute of the timed period, the Game Clock counts down Seconds. A bullet indicator blinks once per second to indicate an active Game Clock whenever the Clock is running.

DIGITS AND INDICATORS: Red or amber light emitting diodes mounted on printed circuit boards form the digits and indicators. Score and Inning digits are 18 inches tall; Pitch Count and Game Clock digits are 11 inches tall.

POWER REQUIREMENTS: **Scoreboard** - 120 VAC, 1.6 A, 60 Hz
Control Console - 120 VAC, 0.5 A, 60 Hz

SCOREBOARD ELECTRONICS: 100% solid state fully enclosed.

CONTROL CONSOLE: The control console features a microprocessor, 37-key sealed membrane keypad, an LCD display, and an attached 6-foot power cord. The console housing consists of ABS plastic base and top pieces with a steel back plate.

CONTROL CABLE: The cable has two 22 AWG stranded copper conductors with semi-rigid PVC insulation. It also has a braided shield and a foil shield. The polyethylene jacket is rated at 300 volts. The cable is direct burial rated and measures approximately 1/4-inch in diameter. This item is sold separately from the scoreboard.

JUNCTION BOX AND EXTENSION CABLE: A 4-1/4-inch x 2-1/4-inch x 2-inch junction box with a 1/4-inch stereo jack mounted on the face plate is attached to the control cable at the point of operation. A 10-foot extension cable connects the control console to the junction box.

SCORELINK RF MODEM SYSTEM: This accessory can be used in place of the control cable and junction box for this scoreboard without internal modifications to the scoreboard or the control console. Refer to the SCORELINK RF MODEM SYSTEM OWNER'S HANDBOOK for more information.

WARRANTY: Five year limited warranty.

SCOREBOARD INSTALLATION

This part of the manual describes the mechanical and electrical installation of the scoreboard.

One of the items listed below must be purchased in order to complete the installation:

- Control cable (length dependent upon installation site layout)
- ScoreLink RF Modem System

Items not provided by Electro-Mech Scoreboard Company that are necessary for installation:

- Two posts (Additional posts may be needed if an alternate configuration is specified.)
- Power cable to connect the scoreboard to the power source
- Grounding hardware
- A grounded NEMA 5-15R 120 VAC receptacle for the control console at the scorekeeper's table.

Items not provided that are recommended by Electro-Mech Scoreboard Company for installation:

- A weatherproof power disconnect at the scoreboard

Electro-Mech Scoreboard Company performs installations in some areas. In other areas, we can help you contact an independent installer. In areas in which installation service is not available from Electro-Mech Scoreboard Company, we will make every effort to answer your installation questions. Qualified personnel should perform the scoreboard installation. Consult national and local codes before installation.

MECHANICAL INSTALLATION

The mechanical installation includes installing the posts and mounting the scoreboard and the optional ID panels (if purchased) to the posts.

Post Installation

The scoreboard, in its standard configuration, mounts on two posts. Typically installers will use steel pipes or I-beams. In order to reduce the glare from the sun on the front of the scoreboard, position the posts so that the front of the scoreboard is angled away from the afternoon sun, if possible. The mounting hardware will accommodate posts up to 7 inches outer diameter. Sink the posts in reinforced concrete footings. Figure 1 shows the spacing of the posts for a Model 1136 scoreboard. The specifications for the posts and concrete footings are dependent upon the expected local wind and soil conditions, the height of the scoreboard from the ground, and the local building codes. Electro-Mech Scoreboard Company assumes no responsibility for the installation of scoreboards by others.

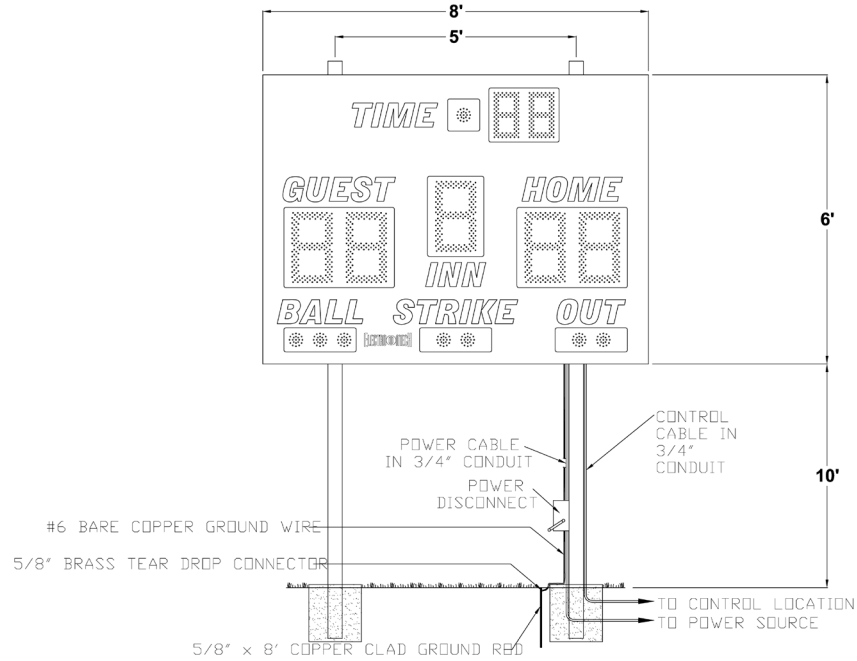

Figure 1 Model 1136 Post Spacing

Figure 2 shows the spacing of the posts for a Model 1136 scoreboard with an optional side ID panel.

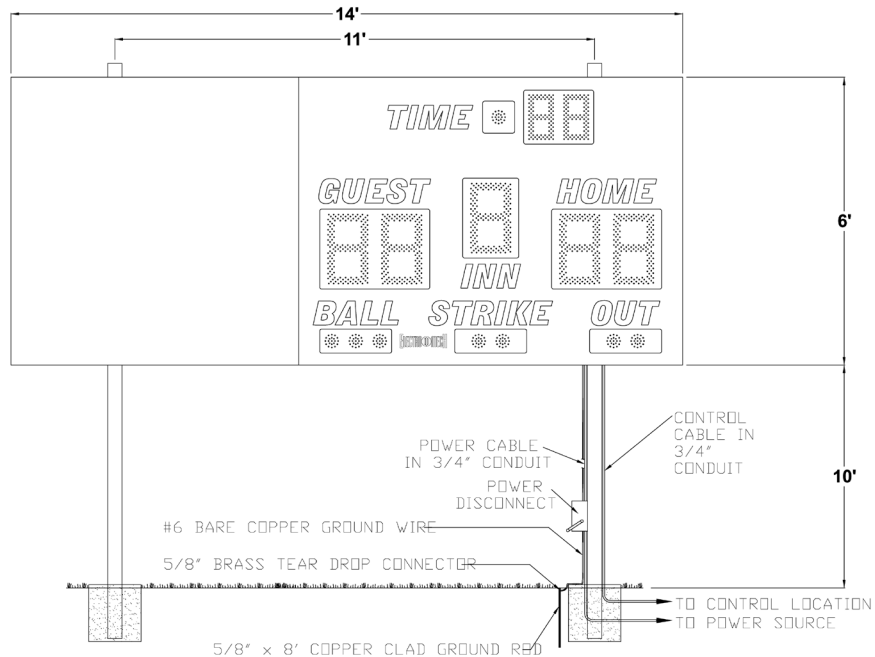

Figure 2 Model 1136 with Side ID Panel Post Spacing

Mounting The Scoreboard

The scoreboard is attached to the posts at four points. Figure 3 shows the location of the mounting points on the rear of the scoreboard.

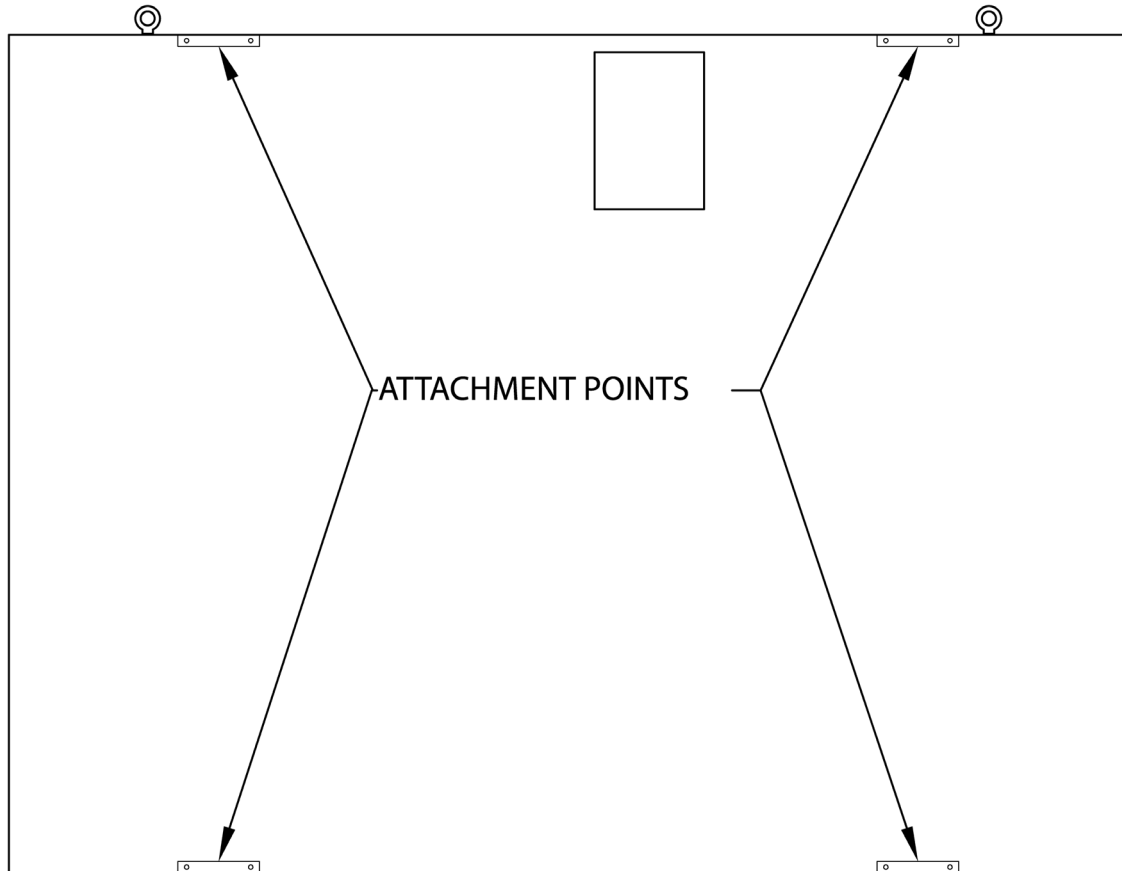

Figure 3 Mounting Points

MOUNTING HARDWARE

Four sets of mounting hardware are provided to attach the scoreboard at these points. Additional hardware sets are provided to attach the optional ID panels, if ordered. A single set of mounting hardware consists of a steel angle bracket, two threaded rods, two washers, and two nuts. Figure 4 shows an overhead cross section view and a side cross section view of the scoreboard attached to a post at a mounting point. A steel bar is riveted inside the scoreboard's aluminum extrusion frame. The bar has two tapped holes. The threaded rods screw into these tapped holes. The washers and nuts are used to clamp the steel angle bracket against the steel post and hold the scoreboard in place.

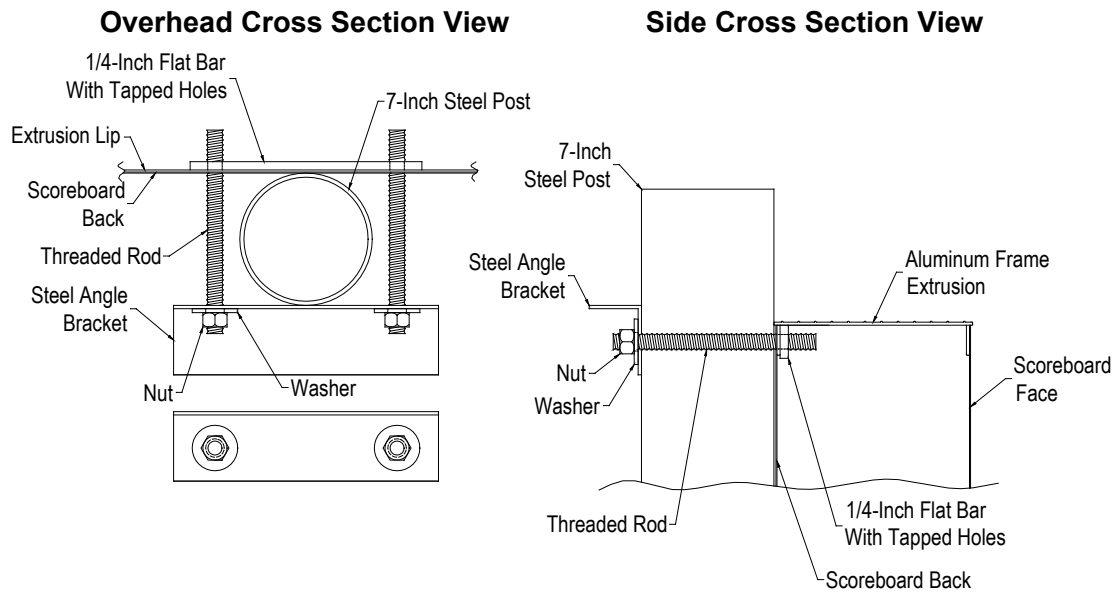

Figure 4 Standard Mounting Method

The following steps describe how to mount the scoreboard on the posts:

1. Place the scoreboard cabinet against the posts on the ground. Make sure the mounting points are aligned with the posts.
2. Screw the threaded rods into the tapped holes in the scoreboard.
3. Place a steel angle bracket over the threaded rods at a mounting point.
4. Place a washer over each threaded rod.
5. Screw the nuts onto the threaded rods so that the bracket is loosely held in place.
6. Repeat steps 2 - 5 at the other mounting points.
7. Raise the scoreboard into place and tighten the nuts to clamp the scoreboard in place on the posts.

Note: Be sure to leave enough space on the posts above the scoreboard for the optional top or bottom ID panel(s), if purchased.

Mounting The Optional Top Or Bottom ID Panel

Additional hardware sets are provided to attach any optional top or bottom ID panels, if purchased. The following steps describe how to mount an ID panel on the posts:

1. Raise the ID panel in place above or below the scoreboard. Make sure the mounting points are aligned with the posts.
2. Screw the threaded rods into the tapped holes in the ID panel.
3. Place a steel angle bracket over the threaded rods at a mounting point.
4. Place a washer over each threaded rod.
5. Screw a nut onto each threaded rod so that the bracket is loosely held in place.
6. Repeat steps 2 - 5 at the other mounting points.
7. Tighten the nuts to clamp the ID panel in place on the posts.

ELECTRICAL INSTALLATION

We recommend a qualified electrician perform the needed electrical connections to ensure proper operation of the scoreboard. These connections include grounding the scoreboard, connecting the scoreboard to a power source, installing the ScoreLink RF Receiver or the control cable, and connecting the control console.

Ground Connection

The National Electrical Code **requires** a scoreboard (electric sign) to be grounded. Grounding the scoreboard helps the scoreboard electronics operate properly and helps minimize damage if it is struck by lightning. Metal posts do **not** provide an adequate ground path. The following steps describe how to ground the scoreboard:

1. Drive one or more 5/8-inch x 8-foot copper clad ground rods in the soil near the scoreboard.
2. Connect #6 bare copper wire to the ground rods using 5/8-inch brass tear drop connectors.
3. Remove the rear access panel and the dome plugs on the plate near the access panel. Figure 5 shows the location of the access panel and the dome plugs.
4. Pass the ground conductor through the one of the knockouts in the plate near the access panel and connect it to the ground lug (**Ground**) on the chassis.

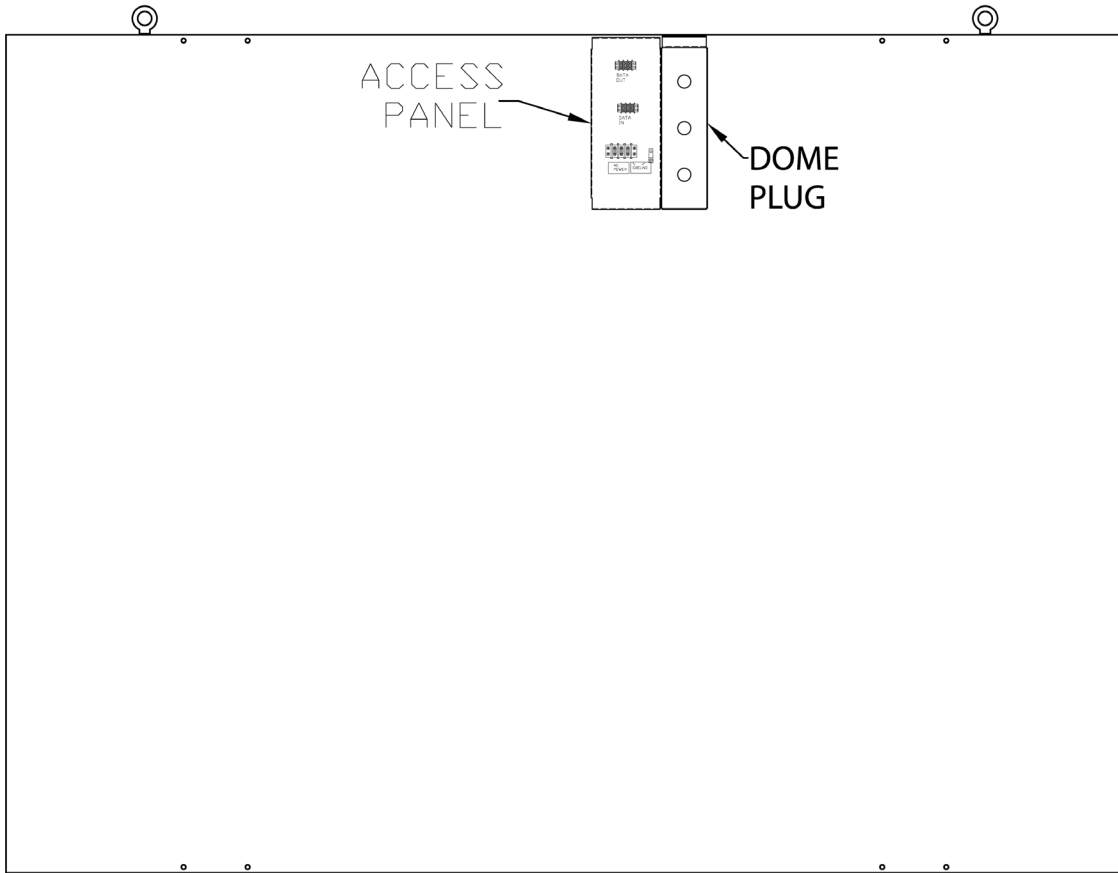

Figure 5 Rear Access Panel

Power Connections

The scoreboard requires 120 VAC, 60 Hz service at the scoreboard to operate properly. **Maximum power consumption of Model 1136: 200 Watts.** Make sure the power cable is rated for this electrical load. Install the power cable in conduit. **Avoid** running the power cable in close proximity to the control cable. The following steps describe how to connect the scoreboard to the power source:

1. Feed the power cable through one of the knockouts in the plate near the access panel.
2. Crimp fork terminals to the power cable wires.
3. Connect the AC line wire and AC neutral wire to the **Main Power** terminal block on the chassis according to figure 6.

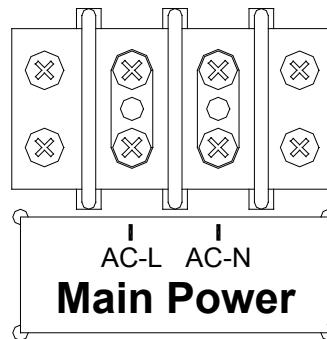

Figure 6 Power Connections

Install a power disconnect that isolates all current carrying conductors (not the ground conductor) on one of the posts below the scoreboard. If a secondary switch is installed near the scorekeeper's table, it should also isolate these conductors. Place the power disconnect in the **OFF** position between games to help protect the scoreboard from lightning damage. A power disconnect on the scoreboard post also provides a convenient way of turning the scoreboard off during maintenance or repairs.

ScoreLink RF Modem System

The SCORELINK RF MODEM SYSTEM is designed to eliminate the control cable between the scoreboard and the control console on Electro-Mech Scoreboard LED scoreboards. If you have purchased this accessory, disregard the section of this manual titled **Control Cable Installation**. Refer to the installation manual provided for this product.

Control Cable Installation

The control cable connects the scoreboard to the control console. Install the control cable in conduit. If the cable is ever damaged, it is easier and less expensive to replace a cable in conduit. A small junction box with a 1/4-inch stereo jack mounted on the face plate is attached to the control cable at the point of operation of the scoreboard. This junction box should be securely mounted in a clean, dry area within ten feet of the rear of the control console. Most customers order the control cable with the junction box attached. Some customers prefer to attach the junction box after the cable is installed. Those customers must solder the control cable to the 1/4-inch stereo jack. Figure 7 shows the control cable wire connection points on the rear of the 1/4-inch stereo jack.

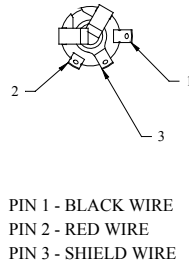

Figure 7 1/4-inch Stereo Jack Wiring Diagram

The following steps describe how to connect the control cable to the scoreboard:

1. At the rear of the scoreboard feed the control cable through one of the knockouts.
2. Crimp fork terminals to the control cable wires and the shield.
3. Connect the control cable to the **Control Cable** terminal block on the chassis according to Figure 8.

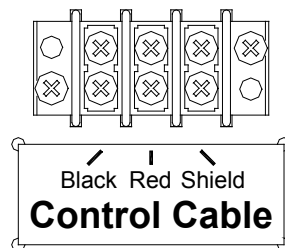

Figure 8 Control Cable Wiring Diagram

4. Reinstall the access panel.

Control Console Connections

The 10 ft. extension cable has two molded 1/4-inch stereo plugs attached to it. It is used to connect the control console to the junction box. The following steps describe how to connect the control console:

1. Plug one end of the extension cable into 1/4-inch stereo jack on the junction box.
2. Plug the other end into the 1/4-inch stereo jack mounted on the control console back plate.
3. Plug the control console power cord into a grounded NEMA 5-15R 120 VAC receptacle.

Control Console Safety Warning

This product is equipped with a 3-wire grounding type plug, a plug having a third (grounding) pin. This plug will only fit into a grounding-type power outlet. This is a safety feature. If you are unable to insert the plug into the outlet, contact a qualified electrician to replace your obsolete outlet. Do not defeat the purpose of the grounding-type plug.

SCOREBOARD OPERATION

SCOREBOARD STARTUP

1. Place the power disconnect for the scoreboard in the **ON** position.
2. Plug one end of the extension cable into 1/4-inch stereo jack on the junction box.
3. Plug the other end into the 1/4-inch stereo jack mounted on the control console back plate.
4. Plug the control console power cord into a grounded NEMA 5-15R 120 VAC receptacle.

GAME TIME OPERATION

This scoreboard is operated with a 37-key control console. Figure 9 shows the keypad layout on the control console.

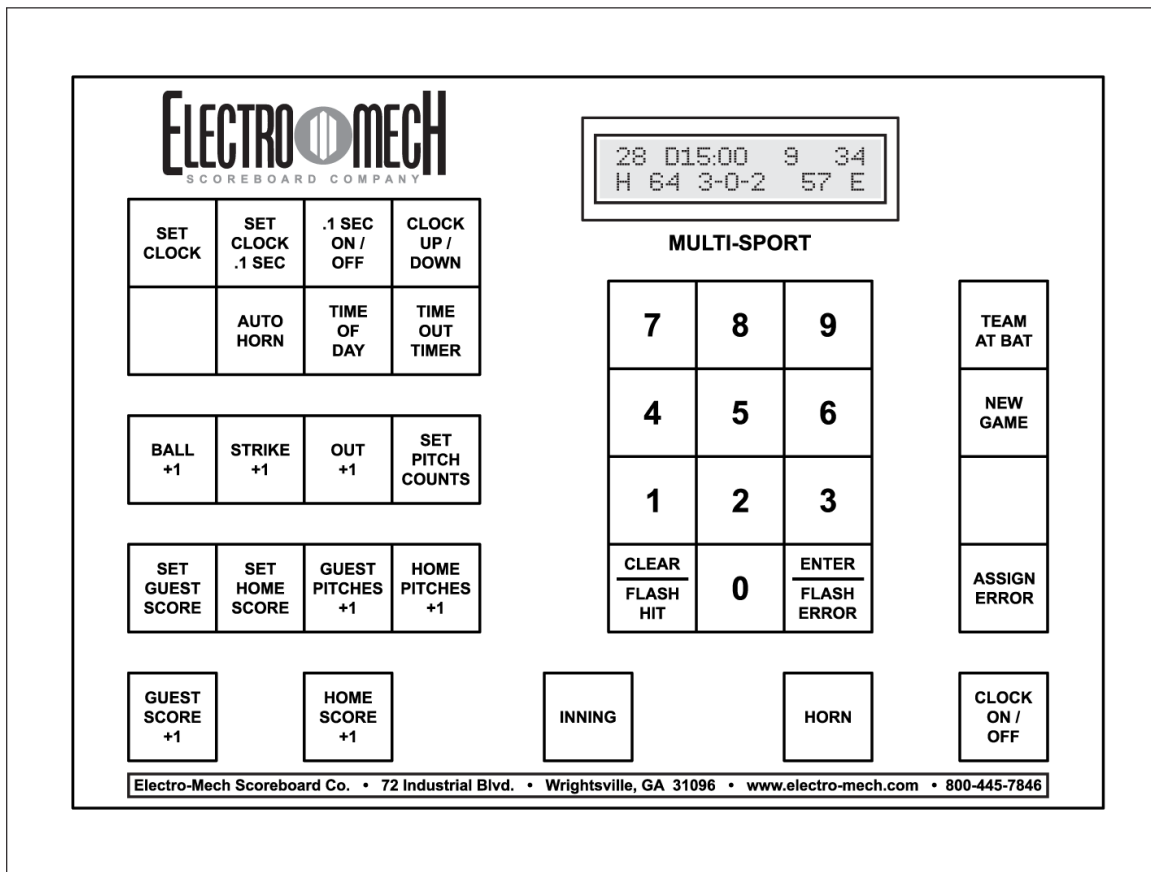

Figure 9 Keypad Layout

Immediately after the control console power cord is plugged into a 120 VAC source, the console LCD display will read:

```
ELECTRO-MECH 314
BASEBALL_1 0C00
```

After a few seconds the display will read:

```
00 D15:00 - 00
.00 0-0-0 00
```

The scoreboard will display:

Guest Score: 0

Home Score: 0

Inning: 0

Time: 15

The control console LCD display shows the total runs for the Guest and Home teams along with a 4-digit Game Clock (or a 3-digit Game Clock for times greater than one hour), Inning, Guest and Home Pitches, and Ball-Strike-Out counts. It also provides instructions to help the operator use some of the console functions. Figure 10 explains the LCD display layout.

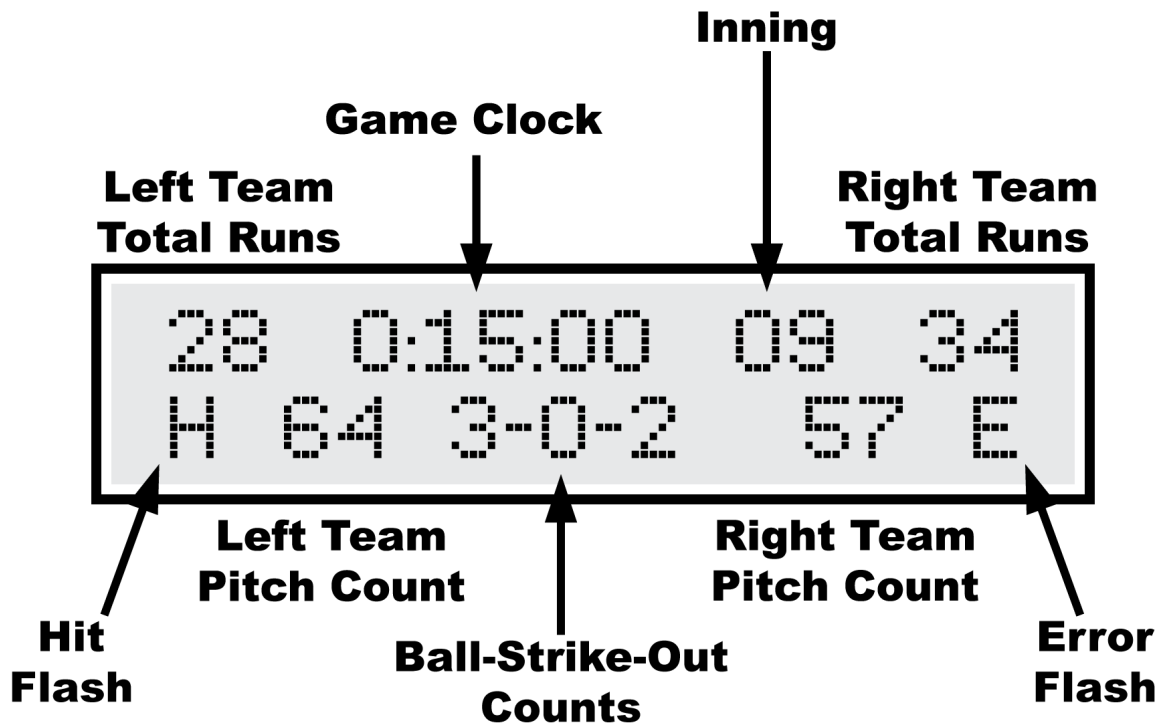

Figure 10 Control Console LCD Display

Control Console Key Functions

Many keys discussed below control features and options not displayed on the Model 1136 scoreboard. For instance, Model 1136 has no Hit/Error indicators or Horn.

1. **SET CLOCK** – This key allows the operator to set the Game Clock to any time from 0:00 to 99:59. The LCD display prompts with the current time. Pressing [ENTER] accepts whatever time value is showing in the lower right prompt area of the LCD. Use the numeric keypad to enter a new time value. For instance, to set the Game Clock to 45:00, first press [SET CLOCK].

00 0:15:00 - 00
SET CLK <15:00>

Press [4] [5] [0] [0] [ENTER] to complete the process.

2. **SET CLOCK .1 SEC** and **1. SEC ON / OFF** – These keys are disabled.
3. **CLOCK UP/DOWN** – Your console can count time up or down. The default Game Clock direction is down-counting. To switch to an up-counting Game Clock, press the [CLOCK UP/DOWN] key.

COUNT UP OR DOWN
1=UP 0=DOWN <0>

Press [1] [ENTER] to select the up-counting Game Clock.

4. **AUTO HORN** – This key allows you to control whether or not the Horn sounds automatically at the end of a period. By default the Horn sounds whenever the Game Clock counts down to 0:00. To disable this behavior, first press [AUTO HORN].

AT END OF PERIOD
1=AUTO 0=OFF <1>

Press [0] [ENTER] to stop the automatic horn function.

5. **TIME OF DAY** and **TIME OUT TIMER** – These keys are present for use with scoreboards that have 4-digit Game Clocks but are disabled in this control console configuration.
6. **BALLS +1** – This key will increment the Ball Count by 1.
7. **STRIKES +1** – This key will increment the Strike Count by 1.
8. **OUTS +1** – This key will increment the Out Count by 1.

9. **SET PITCH COUNTS** – This key is allows the operator to edit the Pitch Counts for both teams. Because some customers prefer the Home team on the left side and some on the right, the function prompts refer to "L" for the team on the left side of the scoreboard and "R" for the team on the right side of the scoreboard.

```
10 0:15:00 04 08
PITCH CNT L<023>
```

Press [0] [ENTER] clear the Pitch Count for the team on the left side of the scoreboard. The LCD then prompts for the other team's Pitch Count:

```
10 0:15:00 04 08
PITCH CNT R<017>
```

Press [0] [ENTER] clear the Pitch Count for the team on the right side of the scoreboard.

10. **SET GUEST/HOME SCORE** – These key are used to edit the Total Runs displayed for each of the two teams. Because Home and Guest captions are swapped on some scoreboards, either key may be labeled "GUEST" or "HOME" on your console. Pressing either one produces the same prompt on the LCD:

```
10 0:15:00 04 08
SET SCORE <10>
```

Press [9] [ENTER] assign 9 Total Runs.

11. **GUEST PITCHES +1** - This key will increment the Guest Pitch Count by 1.
12. **HOME PITCHES +1** - This key will increment the Home Pitch Count by 1.
13. **GUEST SCORE +1** - This key will increment the Guest Total Runs by 1.
14. **HOME SCORE +1** - This key will increment the Home Total Runs by 1.
15. **PERIOD OR INNING** - This key will increment the Inning by 1.
16. **HORN ON/OFF** - This key allows you to manually sound the Horn for scoreboards with that option installed.

17. **CLEAR / FLASH HIT** – This key has two purposes. It can be used to clear incorrect keypad entries. It can also be used to flash the Hit indicator.
18. **ENTER / FLASH ERROR** – This key has two purposes. It is used to complete the entry of data. It can also be used to flash the Error indicator.
19. **CLOCK ON / OFF** - Use this key to start and stop the Game Clock.
20. **ASSIGN ERROR** - This key assigns an Error to a Fielder Position, although there is no Error indicator or Fielder Position display on Model 1136.
21. **TEAM AT BAT** - Use this key to toggle from Guest to Home at bat. This has no affect on Model 1136.
22. **NEW GAME** - This key has the primary function of allowing the control console operator to clear information from the previous game and start fresh. You should do this at the beginning of every game. Press [NEW GAME].

RESET SCOREBOARD
1=YES 0=NO <0>

Press [1] [ENTER] to clear the game memory.

There are several sub-functions available via the New Game menu...

- Press [NEW GAME] [4] to blank everything on the scoreboard. Please remember that this is a diagnostic feature to allow you to test for LEDs that are staying illuminated when they should not; this is not a method for turning off power to the scoreboard.
- Press [NEW GAME] [5] to enter Lamp Test Mode, which turns on all LEDs on the scoreboard.
- Press [NEW GAME] [8] to enter Precision Time Mode. This feature allows for an alternate method of starting and stopping the Game Clock. Hardware requiring this feature includes instructions for using it. Unless you have accessories that require this feature, it is not of any real value. Note that when you are in Precision Time mode, the [CLOCK START / STOP] key does not do anything, and the LCD display shows a "P" in front of the Clock:

30 P12:59 10 38
86 1-2-0 77

You should reset the scoreboard each time that it is turned on. Test out all the functions to ensure that the scoreboard is operating properly.

SCOREBOARD SHUTDOWN

1. Place the power disconnect for the scoreboard in the **OFF** position.
2. Unplug the control console power cord.
3. Unplug the extension cable.
4. Store the control console in a dry location. This unit is not waterproof.

Proper scoreboard shutdown will help protect the scoreboard and control console from power surges and lightning strikes.

SERVICING THE SCOREBOARD

While your scoreboard was designed for years of trouble-free operation, some problems may occasionally occur. Electro-Mech Scoreboard Company offers onsite service in some areas. In other areas, we can help you contact an independent service technician. In areas in which service is not available from Electro-Mech Scoreboard Company, we will make every effort to answer your questions. Our trained personnel at Electro-Mech Scoreboard Company are ready to answer your questions from Monday to Friday during the hours of 8 AM to 5 PM Eastern Standard Time. Be sure to know your scoreboard model number when calling. Scoreboard replacement parts are always available. Damaged parts can usually be repaired at a significant cost savings. Our convenient toll free number is listed at the bottom of every page in this manual.

If the scoreboard turns on LEDs, but does not operate normally, make note of which functions are affected. If some LEDs either never turn on or always stay on, make note of their specific locations on the scoreboard. Refer to the COMPONENT REPLACEMENT section of this manual before changing parts.

COMPONENT REPLACEMENT

LED digits and indicators are serviced from the front of the scoreboard.

LED Digits And Indicators Replacement

The LEDs that form digits and indicators are soldered on circuit boards mounted behind metal masks. Do not attempt to replace individual LEDs. In case of a malfunction, the entire LED circuit board must be removed. **To avoid damage to the LED driver PCB, always turn off the power to the scoreboard when removing or replacing LED digits and indicators.** Figure 11 shows the components of a LED digit assembly. LED indicator assemblies are similar in construction.

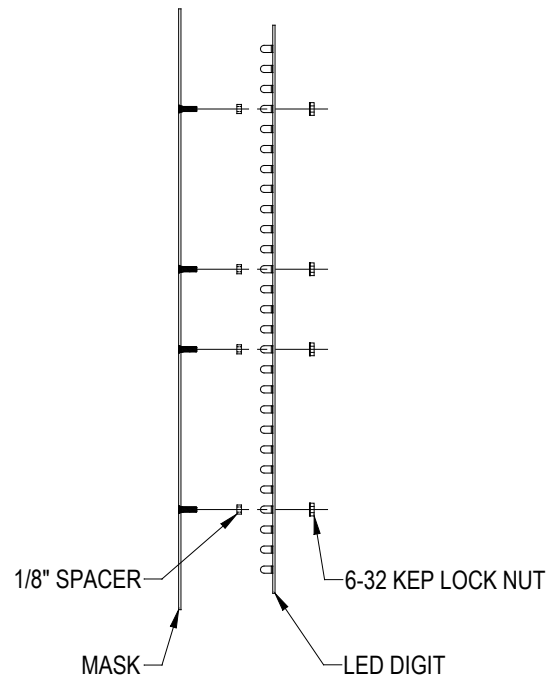
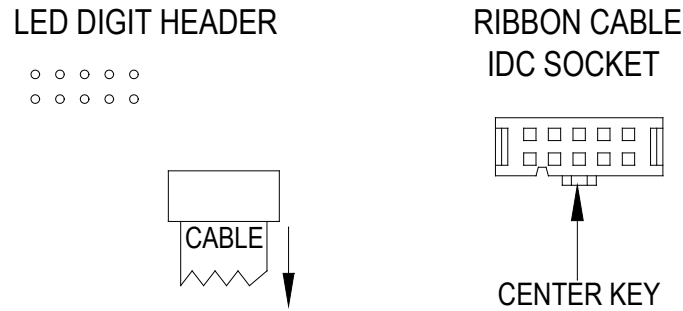

Figure 11 LED Digit Assembly

The following steps describe how to replace a defective LED digit:

1. Remove the sheet metal screws that fasten the mask to the face of the scoreboard.
Caution: Support the mask with your hand before removing the last screw. The ribbon cable that connects to the rear of the circuit board is not designed to support the weight of the assembly.
2. Disconnect the ribbon cable from the rear of the circuit board. For assemblies with two LED digits, it will be necessary to disconnect the ribbon cables from both circuit boards. The cables are labeled to indicate the proper circuit board connection.
Caution: Do not let the cable hang outside of the scoreboard. It is easily cut by sharp metal edges. Damage to the ribbon cable may create short circuit paths that will damage the LED driver PCB.
3. Place the assembly on a flat surface and remove the 6-32 kee lock nuts that hold the defective circuit board in place.
4. Remove the circuit board from the assembly.
5. Align the mounting holes in the replacement LED digit circuit board with the threaded studs on the mask and install it on the mask using the 6-32 kee lock nuts.
6. Plug the ribbon cable onto the header on the back of the circuit board. Refer to figure 12 in order to plug the ribbon cable IDC connector onto the circuit board in the proper orientation.



CENTER KEY ON RIBBON CABLE IDC SOCKET
MUST POINT IN THE SAME DIRECTION AS THE
ARROW ON THE REAR OF THE LED DIGIT.

Figure 12 LED Digit Ribbon Cable Connection Diagram

7. Reinstall the assembly using the sheet metal screws.

All power and driver logic components are located behind the right (as you are facing the scoreboard) score digits -- usually HOME. Figure 13 shows the components with the digit mask removed.

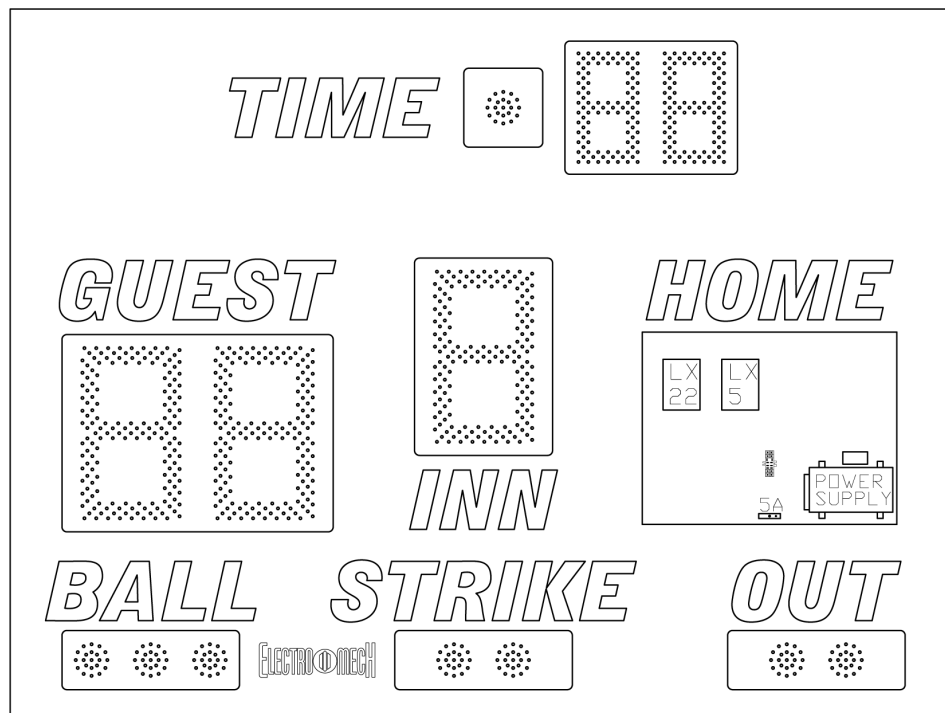

Figure 13 Component Locations

LX Driver Functions and Connections

LX DRIVER PCBs USED IN MODEL 1136	
LX DRIVER	FUNCTIONS CONTROLLED
LX22	Scores, Inning, Ball, Strike, Out
LX5	Clock

LX22 CONNECTORS USED	
PCB JACK	FUNCTION
J3	Output Data
J4	Home Score Units Digit
J5	Home Score Tens Digit
J6	Guest Score Units Digit
J7	DC Power Input
J8	Inning Digit
J9	Guest Score Tens Digit
J10	Ball, Strike, Out Bullets
SHLD, RED, BLK	Input Data

LX5 CONNECTORS USED	
PCB JACK	FUNCTION
J3	Output Data
J6	Minutes Units Digit
J9	Minutes Tens Digit
J7	DC Power Input
J10	Clock Running Indicator
J15	Horn
SHLD, RED, BLK	Input Data

LX Driver PCB Replacement

Electrical connections to the LX Driver Printed Circuit Boards are made with ribbon cable polarized IDC sockets and locking ramp crimp terminal housings that mate with jacks on the PCB. Four machine screws are used to secure a LX Driver PCB inside the scoreboard.

1. Unplug the electrical connections from the PCB. Do not cut the plastic tie wraps around the ribbon cables.
2. Remove the four screws.
3. Remove the PCB from the scoreboard.
4. Insert the replacement PCB in the scoreboard.
5. Secure the PCB with the four screws.
6. Insert the plugs into the jacks on the module.

To avoid damage to the PCB, always turn off the power to the scoreboard when removing or replacing it.

LED Power Supply Module Replacement

The Model 1136 uses a Mean Well SP-320-24 power supply module. Replacement modules are available from Electro-Mech or through distributors of Mean Well power supplies. The power supply must be set to provide 18.9 VDC output, which is how they are configured when shipped from Electro-Mech. Connections are made to a set of screw terminals along the left side of the power supply as illustrated below:

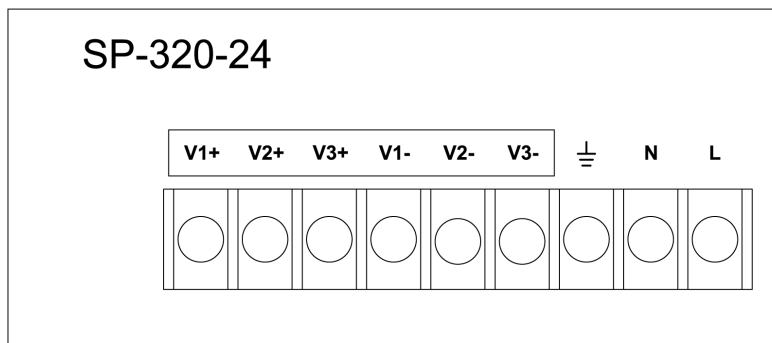

Figure 14 Power Module Screw Terminals

To avoid damage to the power supply module, always turn off the power to the scoreboard when removing or replacing it.

A fuse holder is mounted to the left of the power supply and connected inline with the incoming 120 VAC line side of the power running from the Main Power terminal strip to the Mean Well SP-320 power supply module. The fuse is a 5 amp 250 volt 3AG style fuse and should only be replaced with a fuse of that type.

ELECTRO-MECH SCOREBOARD CO. FIVE YEAR LIMITED WARRANTY

THE ELECTRICAL COMPONENTS OF ALL ELECTRO-MECH SCOREBOARDS ARE GUARANTEED FOR A PERIOD OF FIVE (5) YEARS FROM THE DATE OF INVOICE AGAINST DEFECTS IN WORKMANSHIP OR MATERIAL AND WILL BE REPLACED OR REPAIRED WITHOUT COST TO THE OWNER PROVIDED THE EQUIPMENT OR PARTS ARE RETURNED POSTAGE-PAID TO THE FACTORY IN WRIGHTSVILLE, GA. SHIPPING BACK TO THE OWNER WILL BE VIA UPS GROUND SERVICE EXCEPT WHEN AIR OR SPECIAL METHOD OF RETURN IS SPECIFIED BY THE OWNER, IN WHICH CASE SHIPPING WILL BE FREIGHT COLLECT.

EXCLUDED FROM THIS WARRANTY ARE FUSES.

THIS WARRANTY DOES NOT INCLUDE LABOR CHARGES INCURRED IN THE REMOVAL OF COMPONENT PARTS, SERVICE CALLS, OR DAMAGES RESULTING FROM IMPROPER INSTALLATION, IMPROPER OPERATION, OR PROBLEMS CAUSED BY ANY REPAIR, ALTERATION OR MODIFICATION OF THE SCOREBOARD NOT PERFORMED BY ELECTRO-MECH.

EQUIPMENT WHICH IS SUBJECTED TO ACCIDENT, NEGLIGENCE, ABUSE, MISUSE OR OTHER NATURAL DISASTERS, INCLUDING BUT NOT LIMITED TO FIRE, WIND, LIGHTNING, OR FLOOD, IS NOT COVERED BY THIS GUARANTEE.