

ELECTRO-MECH SCOREBOARD CO.

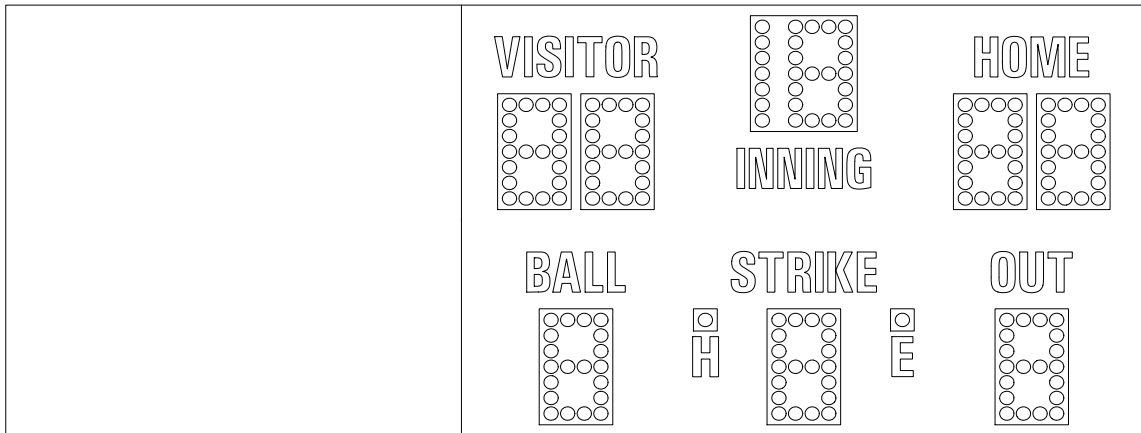

MM-128 BASEBALL SCOREBOARD

OWNER'S HANDBOOK

Thank you for choosing an Electro-Mech Scoreboard for your athletic complex. We are confident that your new scoreboard will give many years of reliable service.

Rev. 2 Revised: 02/09/2007

Electro-Mech Scoreboard Co. • 120 Industrial Parkway • Wrightsville, GA 31096
Phone: (800) 445-7846 • Fax (478) 864-0212 • Email: score@electro-mech.com

TABLE OF CONTENTS

SCOREBOARD SPECIFICATIONS	3
SCOREBOARD INSTALLATION	4
MECHANICAL INSTALLATION	4
Post Installation.....	4
Mounting The Scoreboard	6
MOUNTING HARDWARE	7
Mounting The Side Sponsor Panel	9
Mounting The Optional Top Sponsor Panel	9
ELECTRICAL INSTALLATION.....	10
Ground Connection	10
Power Connections.....	11
ScoreLink 300.....	13
Control Cable Installation.....	13
Control Console Connections	14
Control Console Safety Warning.....	14
SCOREBOARD OPERATION.....	15
SCOREBOARD STARTUP	15
GAME TIME OPERATION.....	15
SCOREBOARD SHUTDOWN.....	16
SERVICING THE SCOREBOARD	17
COMPONENT REPLACEMENT	17
Lamp Replacement	17
Plug In Module Replacement.....	18
WARRANTY	19

SCOREBOARD SPECIFICATIONS

GENERAL: This ETL listed scoreboard includes the scoreboard cabinet, mounting hardware, control console, 10 ft. extension cable, and junction box.

DIMENSIONS: 20' L x 8' H x 6" D (two sections which measure 12' L x 4' H x 6" D each and a 8' x 8' sponsor panel) The optional extra side sponsor panel measures 8' L x 8' H x 6" D.

WEIGHT: 420 lbs (The top scoreboard section weighs 162 lbs, the bottom scoreboard section weighs 142 lbs, and the sponsor panel weighs 110 lbs) The optional extra side sponsor panel weighs 110 lbs.

SCOREBOARD CONSTRUCTION: The outer frame is made from extruded aluminum. Internal structural parts may be extruded aluminum or formed from aluminum sheet. The face and back are made from aluminum sheet. The face and masks are finished with enamel paint. Black is the standard color. The captions are white.

DISPLAY: The MM-128 baseball scoreboard displays HOME and VISITOR scores to 99, INNINGS to 19, BALLS, STRIKES, OUTS, HIT and ERROR.

LAMP BANKS: A 4 x 7 matrix of lamps forms each 24" digit. The INNINGS tens digit is formed by a column of seven lamps. One lamp forms the HIT and one lamp forms the ERROR indicator. The scoreboard uses 15 watt 120 VAC frosted medium based appliance lamps (also known as 15A15IF lamps). Recessed aluminum reflectors provide a crisp separation between each lamp. Expanded metal screens protect the lamps.

POWER REQUIREMENTS: Scoreboard - 120 VAC, 21.125 A, 60 Hz, (25 A service recommended). The scoreboard may be connected to either 120 VAC or 240 VAC single phase. **Control Console** - 120 VAC, 0.5 A, 60 Hz

SCOREBOARD ELECTRONICS: 100% solid state fully enclosed within 2 plug in modules.

CONTROL CONSOLE: The microprocessor control console is constructed of a rugged plastic housing with a metal back plate. It features a 15 key sealed membrane keypad, and an attached 6 foot power cord.

CONTROL CABLE: The cable has two 22 AWG stranded copper conductors with semi-rigid PVC insulation. It also has a braided shield and a foil shield. The polyethylene jacket is rated at 300 volts. The cable is direct burial rated and measures approximately 1/4" in diameter. This item is sold separately from the scoreboard.

JUNCTION BOX AND EXTENSION CABLE: A 4 1/4" x 2 1/4" x 2" junction box with a 1/4" stereo jack mounted on the face plate is attached to the control cable at the point of operation. A 10 ft. extension cable connects the control console to the junction box.

SCORELINK 300 RF MODEM SYSTEM: This accessory can be used in place of control cable and junction box for this scoreboard without internal modifications to the scoreboard or the control console. Refer to the SCORELINK 300 RF MODEM SYSTEM OWNER'S HANDBOOK for more information.

WARRANTY: Five year limited warranty.

SCOREBOARD INSTALLATION

This part of the manual describes the mechanical and electrical installation of the scoreboard.

One of the items listed below must be purchased in order to complete the installation:

- Control cable (length dependent upon installation site layout)
- ScoreLink 300 RF Modem System

Items not provided by Electro-Mech Scoreboard Company that are necessary for installation:

- Three posts (Four posts for MM-128 with optional extra side sponsor panel)
- Power cable to connect the scoreboard to the power source
- Grounding hardware
- A grounded NEMA 5-15R 120 VAC receptacle for the control console at the scorekeeper's table.

Items not provided which are recommended by Electro-Mech Scoreboard Company for installation:

- A weatherproof power disconnect at the scoreboard
- A weatherproof NEMA 5-15R 120 VAC convenience receptacle at the scoreboard

Electro-Mech Scoreboard Company performs installations in some areas. In other areas, we can help you contact an independent installer. In areas in which installation service is not available from Electro-Mech Scoreboard Company, we will make every effort to answer your installation questions. Qualified personnel should perform the scoreboard installation. Consult national and local codes before installation.

MECHANICAL INSTALLATION

The mechanical installation includes installing the posts and mounting the scoreboard and the optional sponsor panels (if purchased) to the posts.

Post Installation

The scoreboard mounts on three posts. Typically installers will use steel pipes or I-beams. In order to reduce the glare from the sun on the front of the scoreboard, position the posts so that the front of the scoreboard is angled away from the afternoon sun, if possible. The mounting hardware will accommodate posts up to 7 inches outer diameter. Sink the posts in reinforced concrete footings. Figure 1 shows the spacing of the posts for the scoreboard. The specifications for the posts and concrete footings are dependent upon the expected local wind and soil conditions, the height of the scoreboard from the ground, and the local building codes. Electro-Mech Scoreboard Company assumes no responsibility for the installation of scoreboards by others.

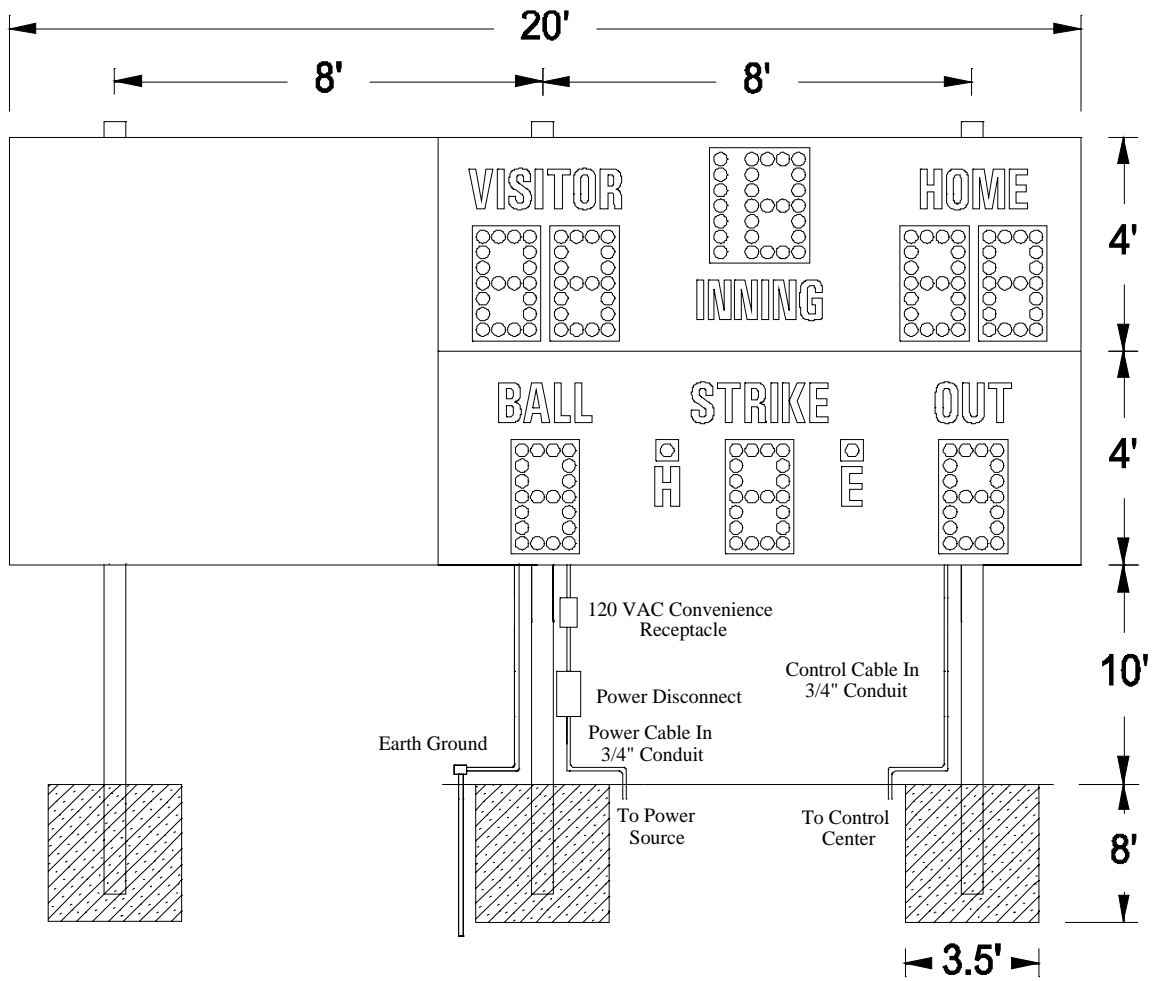

Figure 1 MM-128 Post Spacing

Figure 2 shows the spacing of the posts for a MM-128 with an optional extra side sponsor panel.

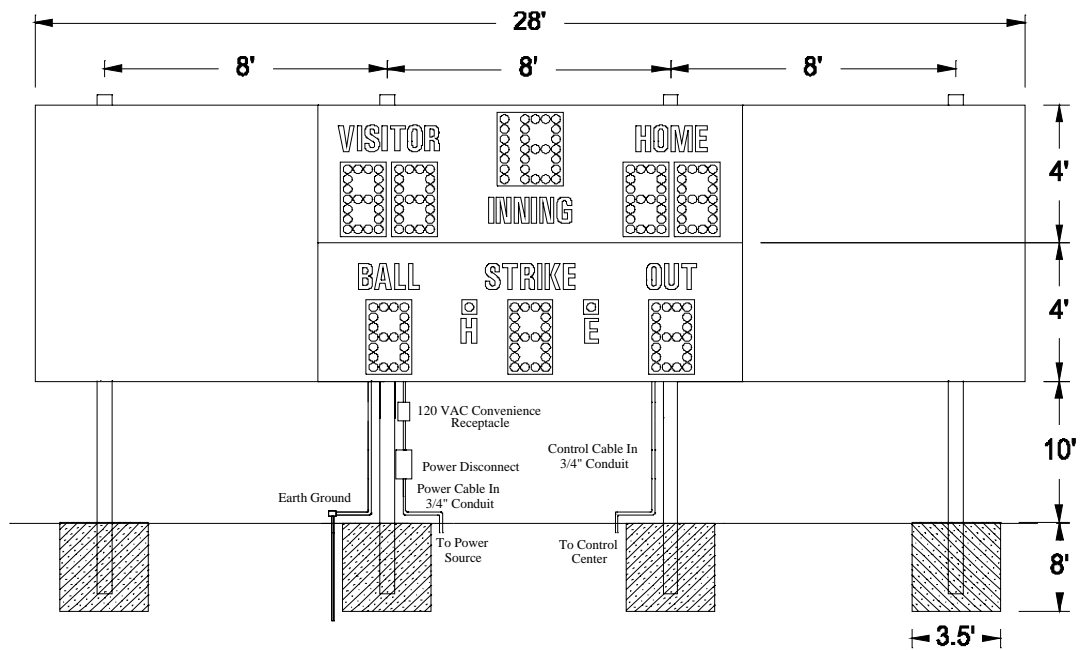

Figure 2 MM-128 with Optional Extra Side Sponsor Panel Post Spacing

Mounting The Scoreboard

The scoreboard is attached to the posts at six points. Figure 3 shows the location of the mounting points on the rear of the scoreboard.

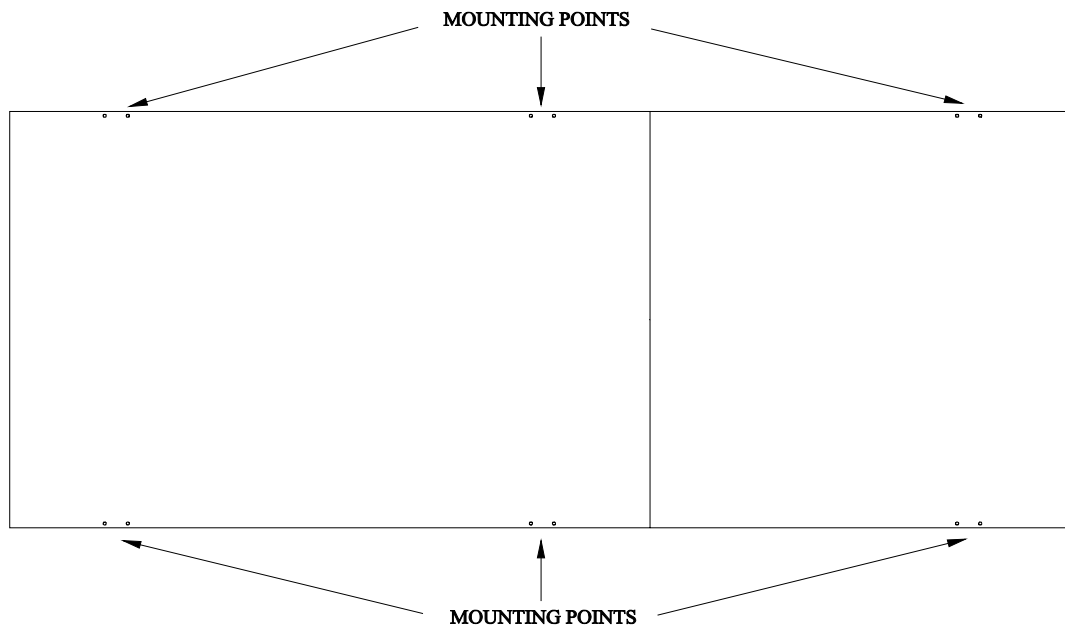

Figure 3 Mounting Points

MOUNTING HARDWARE

Six sets of mounting hardware are provided to attach the scoreboard at these points. Additional hardware sets are provided to attach the optional sponsor panels, if ordered. A single set of mounting hardware consists of a steel angle bracket, two threaded rods, two washers, and two nuts. Figure 4 shows an overhead cross section view and a side cross section view of the scoreboard attached to a post at a mounting point. A steel bar is riveted inside the scoreboard's aluminum extrusion frame. The bar has two tapped holes. The threaded rods screw into these tapped holes. The washers and nuts are used to clamp the steel angle bracket against the steel post and hold the scoreboard in place.

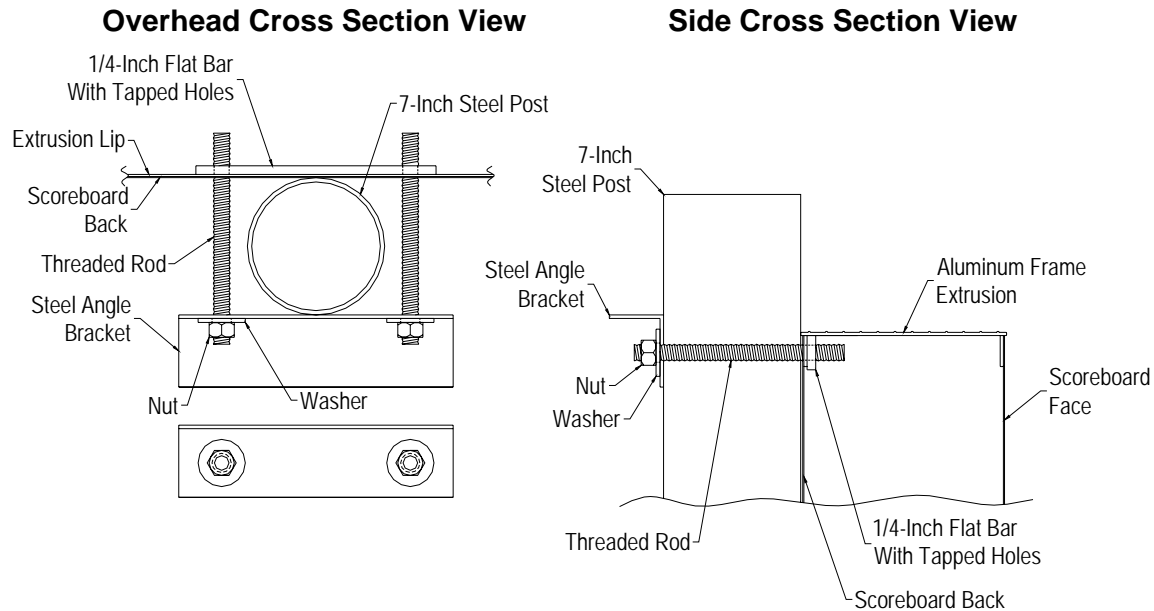

Figure 4 Standard Mounting Method

The following steps describe how to mount the scoreboard on the posts:

1. Place the scoreboard cabinet against the posts on the ground. Make sure the mounting points are aligned with the posts.
2. Screw the threaded rods into the tapped holes in the scoreboard.
3. Place a steel angle bracket over the threaded rods at a mounting point.
4. Place a washer over each threaded rod.
5. Screw the nuts onto the threaded rods so that the bracket is loosely held in place.
6. Repeat steps 3 - 6 at the other mounting points.
7. Raise the scoreboard into place and tighten the nuts to clamp the scoreboard in place on the posts.

Mounting The Side Sponsor Panel

Four bolts and washers are provided to attach the side sponsor panel to the scoreboard. The following steps describe how to attach the sponsor panel to the scoreboard and mount the optional side sponsor panels on the posts:

1. There are four small access panels on the rear of the side sponsor panel. Remove these access panels.
2. Position the sponsor panel next to the scoreboard.
3. Screw the threaded rods into the tapped holes at one of the sponsor panel mounting points.
4. Place a steel angle bracket over the threaded rods at the mounting point.
5. Place a washer over each threaded rod.
6. Screw the nuts onto the threaded rods so that the bracket is loosely held in place.
7. Repeat steps 3 - 6 at the other mounting point.
8. Place a washer over a bolt.
9. Insert the bolt into the top sponsor access panel opening and through the hole in the frame.
10. Screw the bolt into the tapped hole in the scoreboard cabinet.
11. Repeat steps 8-10 at the other three access panel openings.
12. Tighten the nuts to clamp the sponsor panel in place on the post.
13. Re-install the access panels.

Mounting The Optional Top Sponsor Panel

The following steps describe how to mount the top sponsor panel on the posts:

1. Raise the top sponsor panel in place above the scoreboard. Make sure the mounting points are aligned with the posts.
2. Screw the threaded rods into the tapped holes in the top sponsor panel.
3. Place a steel angle bracket over the threaded rods at a mounting point.
4. Place a washer over each threaded rod.
5. Screw a nut onto each threaded rod so that the bracket is loosely held in place.
6. Repeat steps 3 - 5 at the other mounting points.
7. Tighten the nuts to clamp it in place on the posts.

ELECTRICAL INSTALLATION

We recommend a qualified electrician perform the needed electrical connections to ensure proper operation of the scoreboard. These connections include grounding the scoreboard, connecting the scoreboard to a power source, installing the ScoreLink 300 or the control cable, and connecting the control console.

Ground Connection

The National Electrical Code **requires** a scoreboard (electric sign) to be grounded. Grounding the scoreboard helps the scoreboard electronics operate properly and helps minimize damage if it is struck by lightning. Metal posts do **not** provide an adequate ground path. The following steps describe how to ground the scoreboard cabinet:

1. Drive one or more 5/8" x 8' copper clad ground rods in the soil near the scoreboard.
2. Connect #6 bare copper wire to the ground rods using 5/8" brass tear drop connectors.
3. Remove the rear access panel and the dome plugs on the plate below the access panel. Figure 5 shows the location of the access panel and the dome plugs.

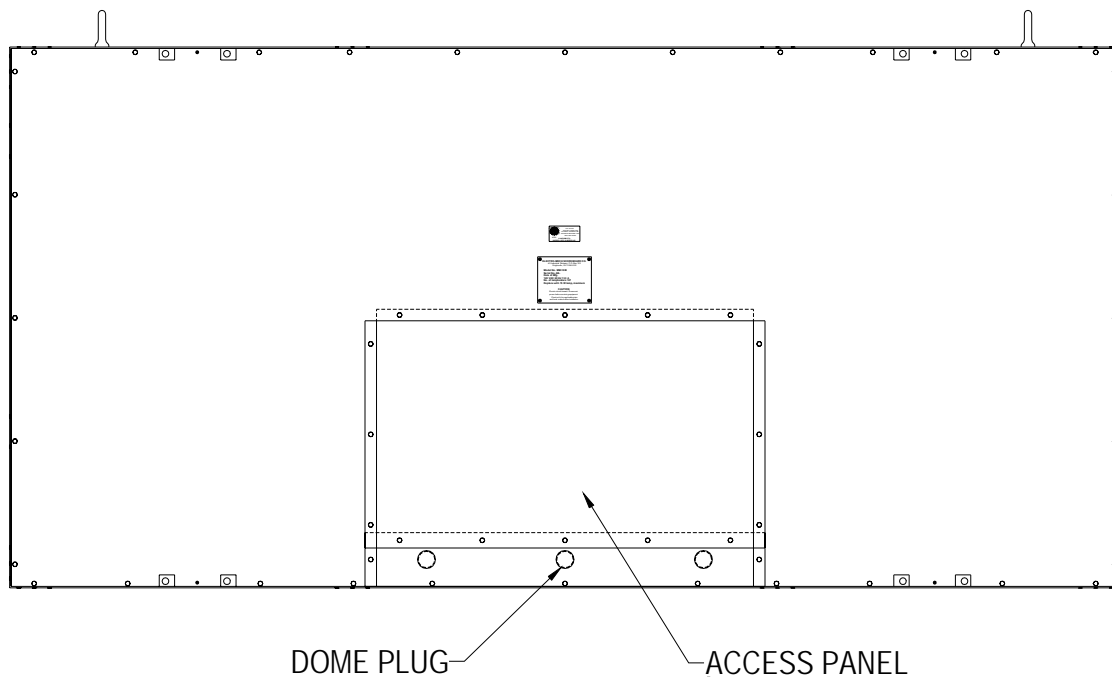

Figure 5 Rear Access Panel

4. Figure 6 shows the view behind the access panel.

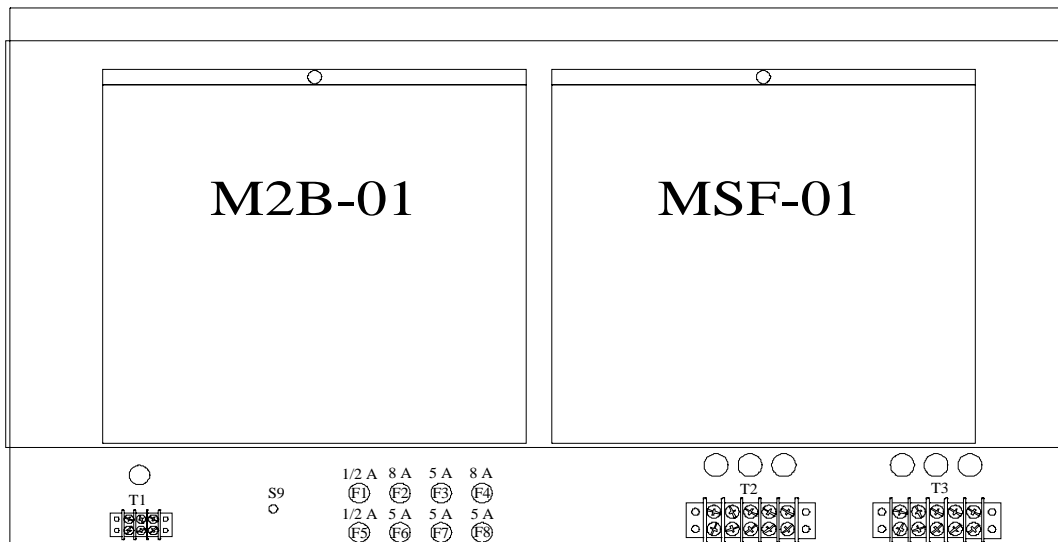

Figure 6 Access Panel Removed

5. Pass the ground conductor through one of the holes in the plate below the access panel and connect it to the frame of the scoreboard.

Power Connections

The scoreboard may be connected to 240 VAC single phase or 120 VAC service at the scoreboard. **Maximum power consumption of Model MM-128: 2535 Watts.** Make sure that power cable is rated for this electrical load. Install the power cable in conduit. **Avoid** running the power cable in close proximity to the control cable. The following steps describe how to connect the scoreboard to your power source:

1. Feed the power cable through a hole in the plate below the access panel.
2. Crimp fork terminals to the power cable wires.
3. If you are going to connect the scoreboard to a 240 VAC supply, connect one AC line wire to position 2, AC neutral wire to position 3, and the other AC line wire to position 4 of terminal strip T3 on the junction chassis according to figure 7.

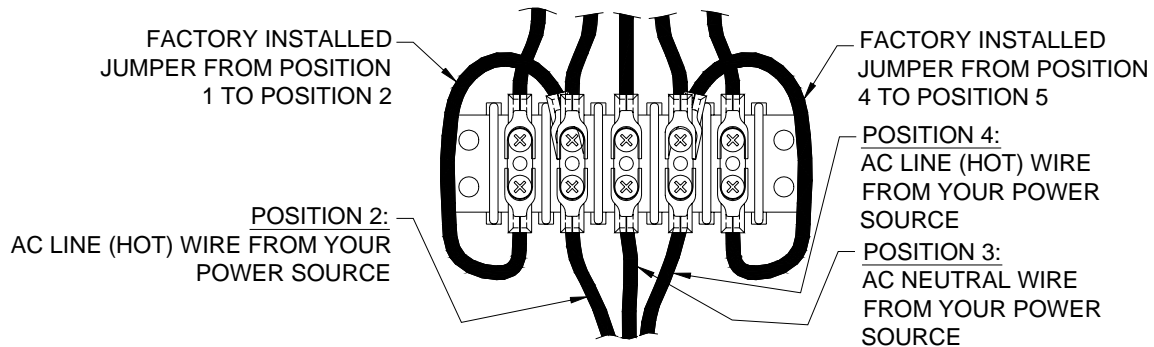

Figure 7 240 VAC Connections

- If you are going to connect the scoreboard to a 120 VAC supply, connect the AC line wire to position 2 and the AC neutral wire to position 3 of terminal strip T3 on the junction chassis. Add a jumper from position 2 to position 4. **This jumper is not provided.** Refer to figure 8.

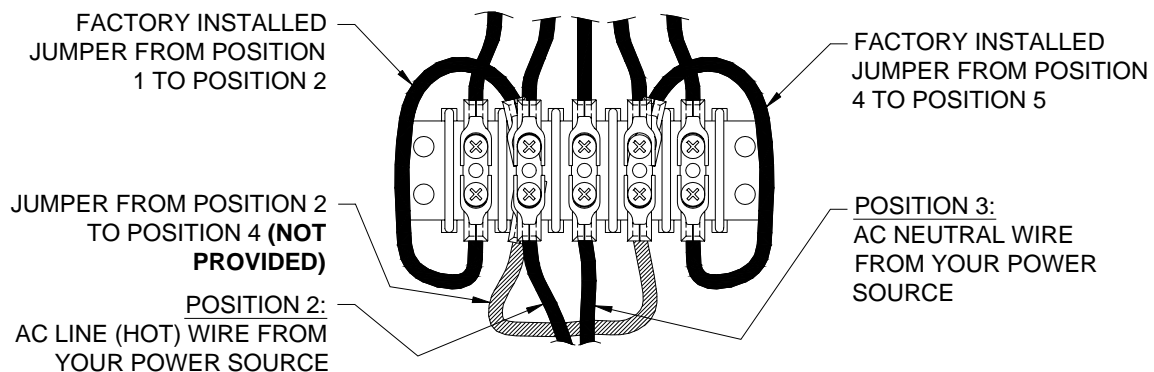

Figure 8 120 VAC Connections

Install a power disconnect that isolates all current carrying conductors on one of the posts below the scoreboard (not the ground conductor). If a secondary switch is installed near the scorekeeper's table, it should also isolate these conductors. Place the power disconnect in the **OFF** position between games to help protect the scoreboard from lightning damage. A power disconnect on the scoreboard post also provides a convenient way of turning the scoreboard off during maintenance or repairs.

ScoreLink 300

The ScoreLink 300 RF MODEM SYSTEM is designed to eliminate the control cable between the scoreboard and the control console on Electro-Mech Scoreboard MM and MP series scoreboards as well as all LED scoreboards. If you have purchased this accessory, disregard the section of this manual titled **Control Cable Installation**. Refer to the ScoreLink 300 RF MODEM SYSTEM OWNER'S HANDBOOK for installation instructions.

Control Cable Installation

The control cable connects the scoreboard to the control console. Install the control cable in conduit. If the cable is ever damaged, it is easier and less expensive to replace a cable in conduit. A small junction box with a 1/4" stereo jack mounted on the face plate is attached to the control cable at the point of operation of the scoreboard. This junction box should be securely mounted in a clean, dry area within ten feet of the rear of the control console. Most customers order the control cable with the junction box attached. Some customers prefer to attach the junction box after the cable is installed. Those customers must solder the control cable to the 1/4" stereo jack. Figure 9 shows the control cable wire connection points on the rear of the 1/4" stereo jack.

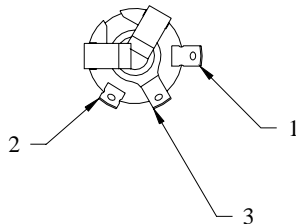

PIN 1 - BLACK WIRE
PIN 2 - RED WIRE
PIN 3 - SHIELD WIRE

Figure 9 1/4" Stereo Jack Wiring Diagram

The following steps describe how to connect the control cable to the scoreboard:

1. At the rear of the scoreboard feed the control cable the left hole in the plate below the access panel.
2. Crimp fork terminals to the control cable wires and the shield.
3. Connect the control cable to terminal strip T1 (located to the left of the test jack S9) according to the diagram in figure 10.

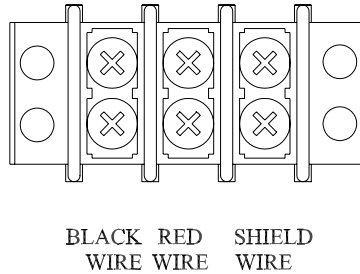

Figure 10 T1 Wiring Diagram

Control Console Connections

The 10 ft. extension cable has two molded ¼” stereo plugs attached to it. It is used to connect the control console to the junction box. The following steps describe how to connect the control console:

1. Plug one end of the extension cable into ¼” stereo jack on the junction box or the ScoreLink 300 Transmitter, if purchased.
2. Plug the other end into the ¼” stereo jack mounted on the control console back plate.
3. Plug the control console power cord into a grounded NEMA 5-15R 120 VAC receptacle.

Control Console Safety Warning

This product is equipped with a 3-wire grounding type plug, a plug having a third (grounding) pin. This plug will only fit into a grounding-type power outlet. This is a safety feature. If you are unable to insert the plug into the outlet, contact a qualified electrician to replace your obsolete outlet. Do not defeat the purpose of the grounding-type plug.

SCOREBOARD OPERATION

SCOREBOARD STARTUP

1. Place the power disconnect for the scoreboard in the **ON** position.
2. Plug one end of the 10 ft. extension cable into ¼" stereo jack on the junction box or the ScoreLink 300 Transmitter, if purchased.
3. Plug the other end into the ¼" stereo jack mounted on the control console back plate.
4. Plug the control console power cord into a grounded NEMA 5-15R 120 VAC receptacle.
5. If a ScoreLink 300 RF MODEM SYSTEM is installed with this scoreboard, plug the wall mount DC power supply into a grounded NEMA 5-15R 120 VAC receptacle and the male plug on the end of the attached cable into the Power jack on the Transmitter.

GAME TIME OPERATION

This scoreboard is operated with a simple 15-key control console. Figure 11 shows the keypad layout on the control console.

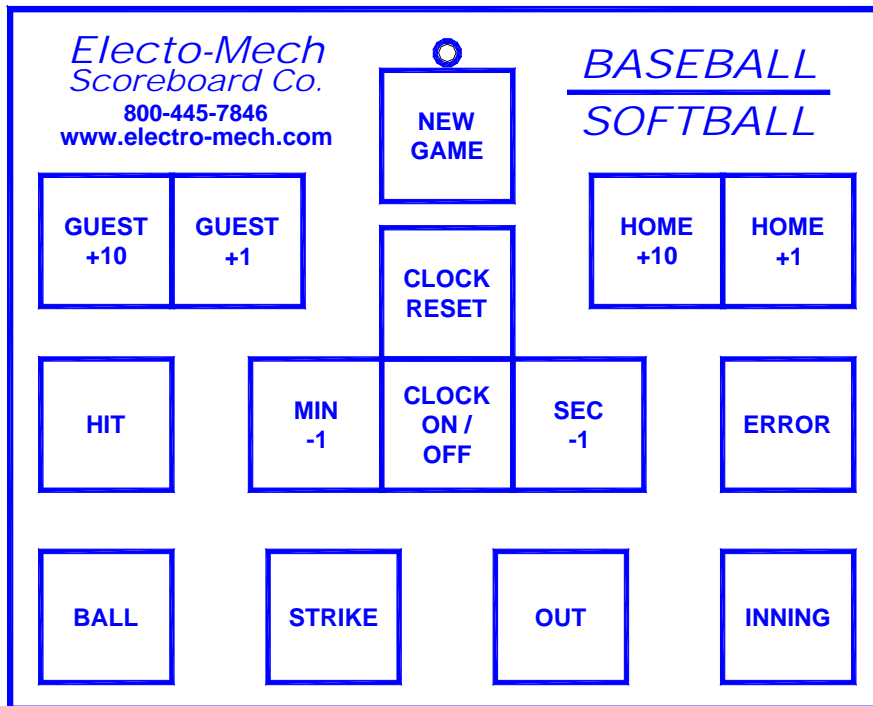

Figure 11 Keypad Layout

Control Console Key Functions

1. **GUEST +1** – This key increments the Guest score by 1.
2. **HOME +1** – This key increments the Home score by 1.
3. **GUEST +10** – This key increments the Guest score by 10.
4. **HOME + 10** – This key increments the Home score by 10.
5. **INNING** – This key increments the Inning by 1.
6. **BALLS** – This key increments the Ball count by 1.
7. **STRIKES** – This key increments the Strike count by 1.
8. **OUTS** – This key increments the Out count by 1.
9. **HIT** – This key activates the blinking Hit indicator.
10. **ERROR** – This key activates the blinking Error indicator.
11. **NEW GAME** – This key is used with the **CLOCK RESET** key to reset all scoreboard functions. Press [NEW GAME] and, within two seconds, press [CLOCK RESET]. The HOME score, GUEST score, and INNING will display zero. The BALLS, STRIKES, and OUTS will be blanked.
12. **CLOCK RESET** – This key is used only in conjunction with the **NEW GAME** key.

The **DEC. MIN.**, **DEC. SEC.**, and **CLOCK ON/OFF** keys are not used with the MM-128 scoreboard.

You should reset the scoreboard each time that it is turned on. Test all the functions to ensure that the scoreboard is operating properly.

SCOREBOARD SHUTDOWN

1. Place the power disconnect for the scoreboard in the **OFF** position.
2. Unplug the control console power cord.
3. Unplug the 10 ft. extension cable.
4. If a ScoreLink 300 RF MODEM SYSTEM is installed with this scoreboard, unplug the Transmitter's wall mount power supply.
5. Store the control console and ScoreLink 300 transmitter in a dry location. These units are not waterproof.

Proper scoreboard shutdown will help protect the scoreboard and control console from power surges and lightning strikes.

SERVICING THE SCOREBOARD

While your scoreboard was designed for years of trouble-free operation, some problems may occasionally occur. Our trained personnel at Electro-Mech Scoreboard Company are ready to answer your questions from Monday to Friday during the hours of 8 AM to 5 PM Eastern Standard Time. Be sure to know your scoreboard model number when calling. Scoreboard replacement parts, including lamps, are always available. Electro-Mech Scoreboard Company can repair the control console and plug in modules at a significant savings when compared to the price of new units. Our convenient toll free number is listed at the bottom of every page in this manual.

If the scoreboard turns on lamps, but does not operate normally, make note of which functions are affected. If some lamps either never turn on or always stay on, make note of their specific locations on the scoreboard. Refer to the LAMP REPLACEMENT section of this manual before changing lamps.

COMPONENT REPLACEMENT

Lamp Replacement

Remove the protective mask covering each lamp bank to access the lamps. **To avoid damage to the plug in module, always turn off the power to the scoreboard when changing lamps.** We recommend using a felt pen or tape to mark lamps that will not light. The scoreboard uses 15 watt 120 VAC frosted medium based appliance lamps (also known as 15A15IF lamps). **Never replace these with higher wattage lamps.**

All other components are located behind the rear access panel. Figure 12 shows the components behind the access panel.



Figure 12 Access Panel Components

The plug in module MSF-01 operates VISITOR SCORE, HOME SCORE, and INNINGS. The plug in module M2B-01 operates BALLS, STRIKES, OUTS, HIT and ERROR.

Plug In Module Replacement

Each module has four bottom plugs that mate with sockets on the junction chassis. A screw located at the top of the module holds it against the junction chassis. Remove the screw and pull the module upward to unseat the module. **To avoid damage to the plug in module, always turn off the power to the scoreboard when removing or replacing it.**

FUSES

FUSE	RATING	FUNCTION	BUSSMAN PART #
F1	1/2 A 250 V	CONTROL LINE	AGC-1/2
F2	8 A 250 V	HOME SCORE	AGC-8
F3	5 A 250 V	INNINGS	AGC-5
F4	8 A 250 V	VISITOR SCORE	AGC-8
F5	1/2 A 250 V	CONTROL LINE	AGC-1/2
F6	5 A 250 V	BALLS	AGC-5
F7	5 A 250 V	STRIKES	AGC-5
F8	5 A 250 V	OUTS	AGC-5

Note: Other manufacturers' fuses may be substituted for the Bussmann fuses.

ELECTRO-MECH SCOREBOARD CO. FIVE YEAR LIMITED WARRANTY

THE ELECTRICAL COMPONENTS OF ALL ELECTRO-MECH SCOREBOARDS ARE GUARANTEED FOR A PERIOD OF FIVE (5) YEARS FROM THE DATE OF INVOICE AGAINST DEFECTS IN WORKMANSHIP OR MATERIAL AND WILL BE REPLACED OR REPAIRED WITHOUT COST TO THE OWNER PROVIDED THE EQUIPMENT OR PARTS ARE RETURNED POSTAGE-PAID TO THE FACTORY IN WRIGHTSVILLE, GA. SHIPPING BACK TO THE OWNER WILL BE VIA UPS GROUND SERVICE EXCEPT WHEN AIR OR SPECIAL METHOD OF RETURN IS SPECIFIED BY THE OWNER, IN WHICH CASE SHIPPING WILL BE FREIGHT COLLECT.

EXCLUDED FROM THIS WARRANTY ARE LAMPS, FUSES AND SOCKETS.

THIS WARRANTY DOES NOT INCLUDE LABOR CHARGES INCURRED IN THE REMOVAL OF COMPONENT PARTS, SERVICE CALLS, OR DAMAGES RESULTING FROM IMPROPER INSTALLATION, IMPROPER OPERATION, OR PROBLEMS CAUSED BY ANY REPAIR, ALTERATION OR MODIFICATION OF THE SCOREBOARD NOT PERFORMED BY ELECTRO-MECH.

EQUIPMENT WHICH IS SUBJECTED TO ACCIDENT, NEGLIGENCE, ABUSE, MISUSE OR OTHER NATURAL DISASTERS, INCLUDING BUT NOT LIMITED TO FIRE, WIND, LIGHTNING, OR FLOOD, IS NOT COVERED BY THIS GUARANTEE.