

ELECTRO-MECH SCOREBOARD CO.

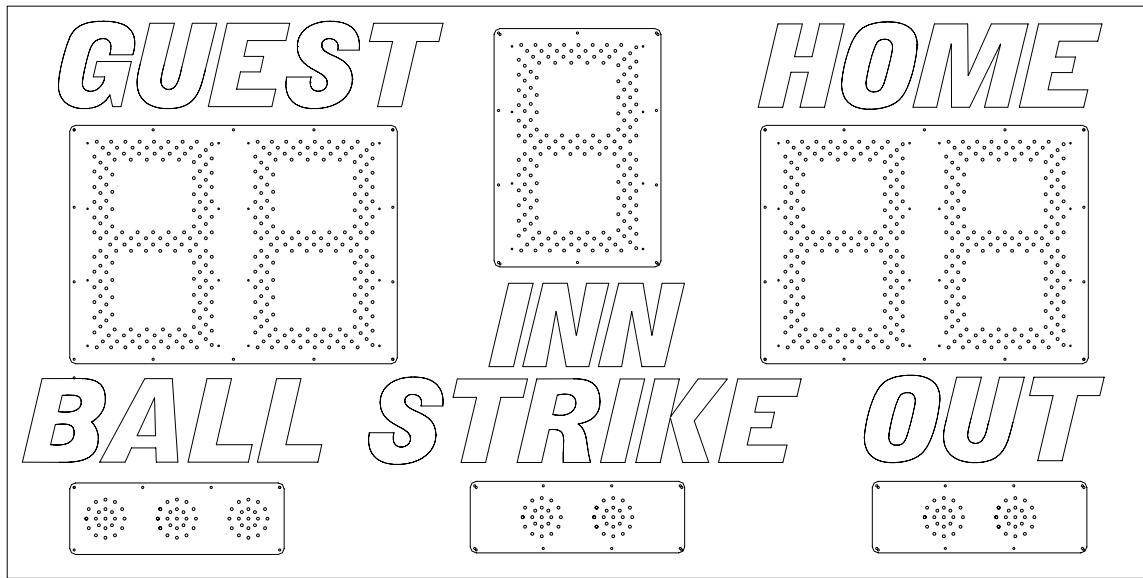

1030 BASEBALL SCOREBOARD

OWNER'S HANDBOOK

Thank you for choosing an Electro-Mech Scoreboard for your athletic complex. We are confident that your new scoreboard will give many years of reliable service.

Rev. 3 Revised:07/12/2007

TABLE OF CONTENTS

SCOREBOARD SPECIFICATIONS	3
SCOREBOARD INSTALLATION	4
MECHANICAL INSTALLATION	4
Post Installation.....	4
Mounting The Scoreboard	8
MOUNTING HARDWARE	9
Mounting The Optional Top Sponsor Panel	11
ELECTRICAL INSTALLATION	11
Ground Connection	11
Power Connections.....	13
SL-230 / 330	13
Control Cable Installation.....	14
Control Console Connections	14
Control Console Safety Warning.....	15
SCOREBOARD OPERATION.....	16
SCOREBOARD STARTUP	16
GAME TIME OPERATION.....	16
SCOREBOARD SHUTDOWN.....	17
SERVICING THE SCOREBOARD.....	18
COMPONENT REPLACEMENT	18
LED Digits And Indicators Replacement	18
LX Driver Board Replacement.....	20
LED Power Supply Module Replacement	22
WARRANTY	23

SCOREBOARD SPECIFICATIONS

GENERAL: This ETL listed scoreboard includes the scoreboard cabinet, mounting hardware, control console, 10 ft. extension cable, and junction box.

DIMENSIONS: 8' L x 4" H x 6" D; 1030 with side ad panel: 12' L x 5' H x 6" D; 1030 with two side ad panels: 16' L x 5' H x 6" D

WEIGHT: 110 lbs; 1030 with side ad panel: 205 lbs; 1030 with two side ad panels: 250 lbs

SCOREBOARD CONSTRUCTION: The outer frame is made from extruded aluminum. Internal structural parts may be extruded aluminum or formed from aluminum sheet. The face and back are made from aluminum sheet. The face and masks are finished with enamel paint. Black is the standard color. The captions are white.

DISPLAY: The 1030 baseball scoreboard displays HOME and GUEST scores to 99, INNINGS (INN) to 9, BALLS (BALL), STRIKES (STRIKE), and OUTS (OUT).

DIGITS AND INDICATORS: Red light emitting diodes mounted on printed circuit boards form the digits and indicators. The digits are 18" tall. Circular clusters of light emitting diodes form the 4" diameter BALLS, STRIKES, and OUTS indicators.

POWER REQUIREMENTS: **Scoreboard** - 120 VAC, 1 A, 60 Hz **Control Console** - 120 VAC, 0.5 A, 60 Hz

SCOREBOARD ELECTRONICS: 100% solid state fully enclosed.

CONTROL CONSOLE: The control console features a microprocessor, 15 key sealed membrane keypad and an attached 6 foot power cord. The console housing consists of ABS plastic base and top pieces with a steel back plate.

CONTROL CABLE: The cable has two 22 AWG stranded copper conductors with semi-rigid PVC insulation. It also has a braided shield and a foil shield. The polyethylene jacket is rated at 300 volts. The cable is direct burial rated and measures approximately 1/4" in diameter. This item is sold separately from the scoreboard.

JUNCTION BOX AND EXTENSION CABLE: A 4 1/4" x 2 1/4" x 2" junction box with a 1/4" stereo jack mounted on the face plate is attached to the control cable at the point of operation. A 10 ft. extension cable connects the control console to the junction box.

SL-230 / 330 RF MODEM SYSTEM: This accessory can be used in place of control cable and junction box for this scoreboard. Refer to the SL-230 / 330 RF MODEM INSTALLATION MANUAL for more information.

WARRANTY: Five year limited warranty.

SCOREBOARD INSTALLATION

This part of the manual describes the mechanical and electrical installation of the scoreboard.

One of the items listed below must be purchased in order to complete the installation:

- Control cable (length dependent upon installation site layout)
- SL-230 / 330 RF Modem System

Items not provided by Electro-Mech Scoreboard Company that are necessary for installation:

- Two posts
- Power cable to connect the scoreboard to the power source
- Grounding hardware
- A grounded NEMA 5-15R 120 VAC receptacle for the control console at the scorekeeper's table.

Items not provided that are recommended by Electro-Mech Scoreboard Company for installation:

- A weatherproof power disconnect at the scoreboard

Electro-Mech Scoreboard Company performs installations in some areas. In other areas, we can help you contact an independent installer. In areas in which installation service is not available from Electro-Mech Scoreboard Company, we will make every effort to answer your installation questions. Qualified personnel should perform the scoreboard installation. Consult national and local codes before installation.

MECHANICAL INSTALLATION

The mechanical installation includes installing the posts and mounting the scoreboard and the optional top sponsor panels (if purchased) to the posts.

Post Installation

The scoreboard mounts on two posts. Typically installers will use steel pipes or I-beams. In order to reduce the glare from the sun on the front of the scoreboard, position the posts so that the front of the scoreboard is angled away from the afternoon sun, if possible. The mounting hardware will accommodate posts up to 4.5 inches outer diameter. Sink the posts in reinforced concrete footings. Figure 1 shows the spacing of the posts for a 1030 scoreboard. The specifications for the posts and concrete footings are dependent upon the expected local wind and soil conditions, the height of the scoreboard from the ground, and the local building codes. Electro-Mech Scoreboard Company assumes no responsibility for the installation of scoreboards by others.

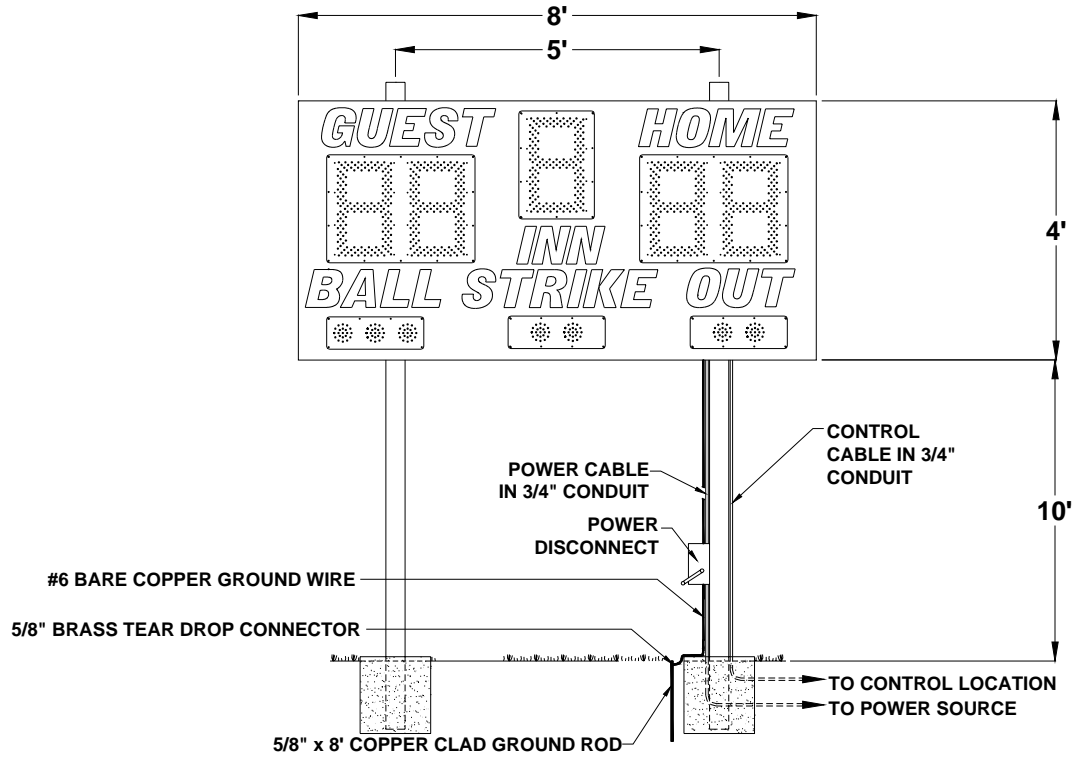

Figure 1 1030 Post Spacing

Figure 2 shows the spacing of the posts for a 1030 scoreboard with an optional top sponsor panel. This panel is a separate unit that mounts on the same posts as the scoreboard.

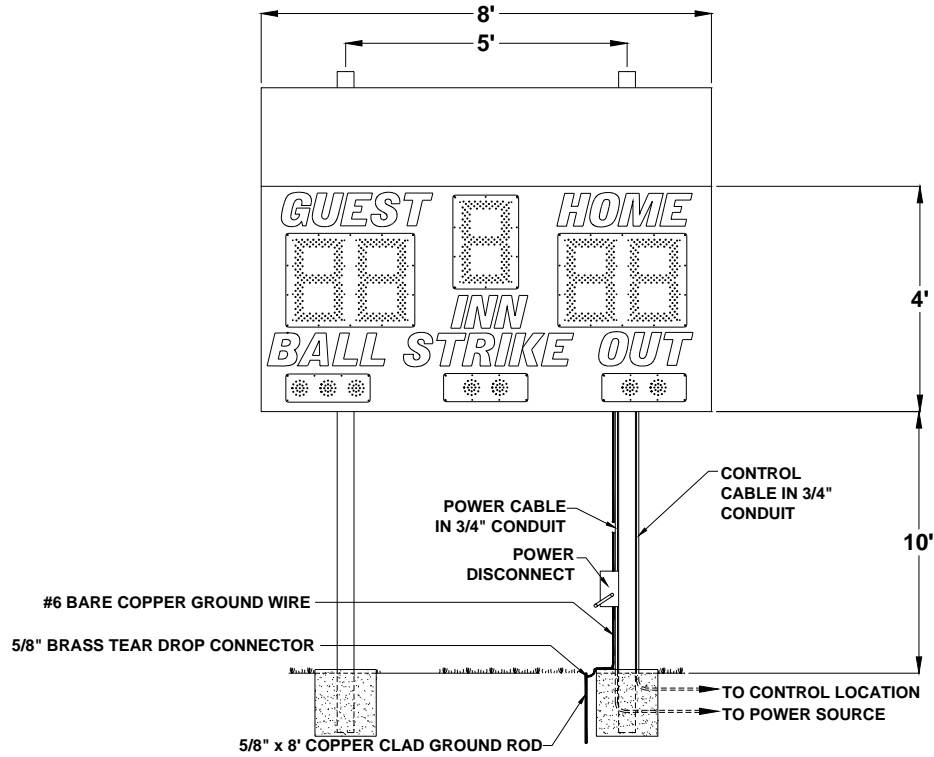

Figure 2 1030 with Optional Top Sponsor Panel Post Spacing

Figure 3 shows the spacing of the posts for a 1030 scoreboard with optional bottom and side sponsor panels built into the scoreboard frame.

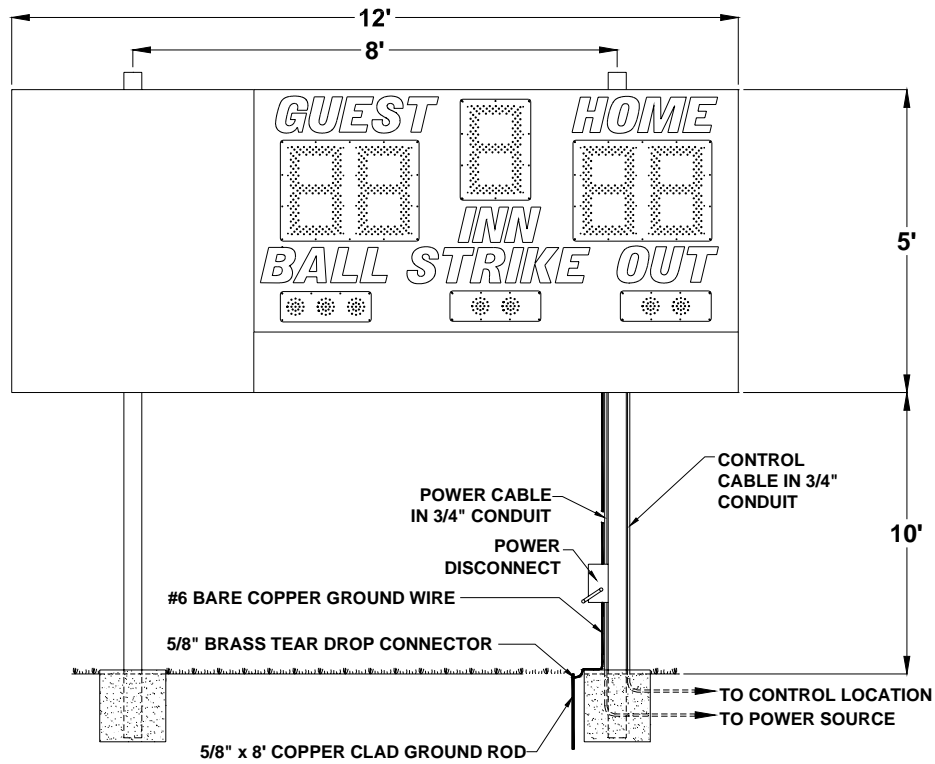
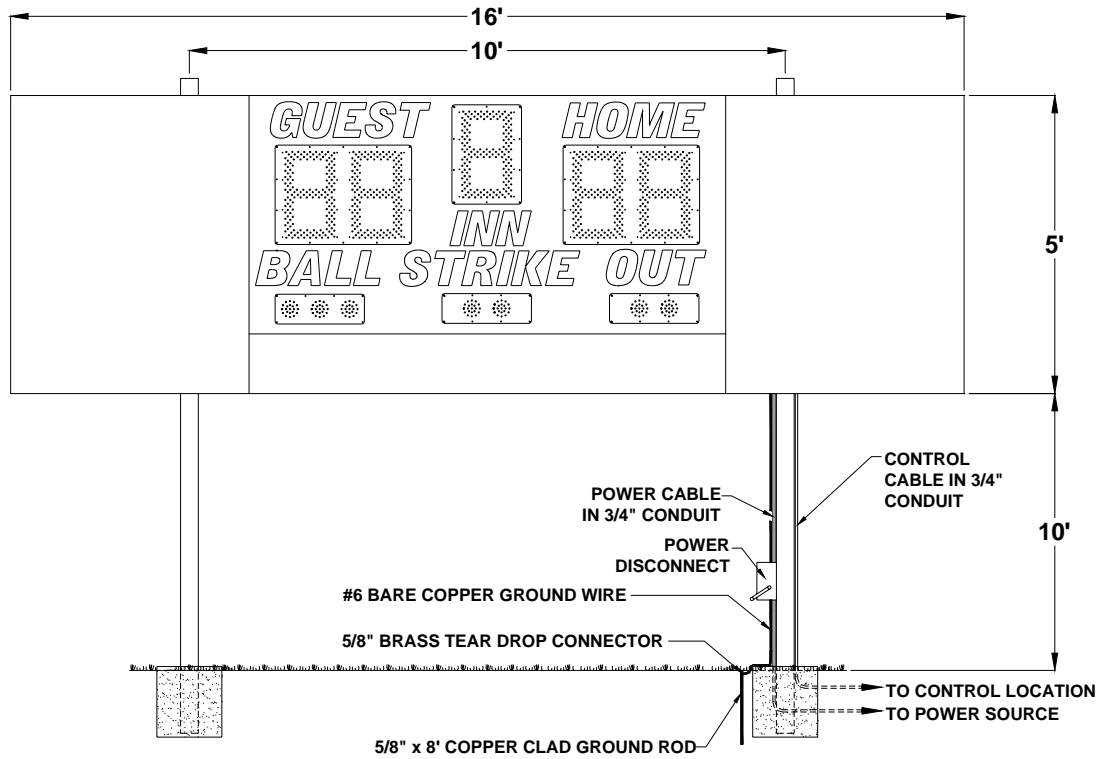

Figure 3 1030 with Optional Bottom and Side Sponsor Panels Post Spacing

Figure 4 shows the spacing of the posts for a 1030 scoreboard with two side sponsor panels and a bottom sponsor panel built into the scoreboard frame.



**Figure 4 1030 with Optional Bottom and Two Side Sponsor Panels Post Spacing
Mounting The Scoreboard**

The scoreboard is attached to the posts at four points. Figure 5 shows the location of the mounting points on the rear of the scoreboard.

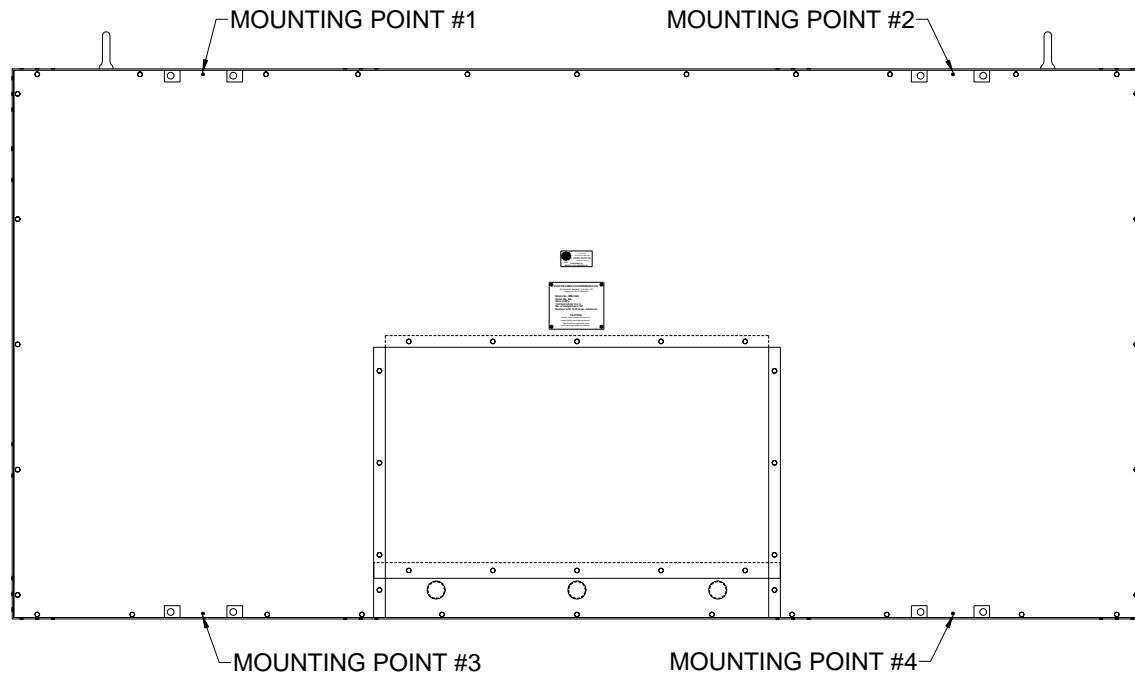

Figure 5 Mounting Points

MOUNTING HARDWARE

Four sets of mounting hardware are provided to attach the scoreboard at these points. Additional hardware sets are provided to attach the optional top sponsor panels, if ordered. A single set of mounting hardware consists of a steel angle bracket, two threaded rods, two washers, and two nuts. Figure 6 shows an overhead cross section view and a side cross section view of the scoreboard attached to a post at a mounting point. A steel bar is riveted inside the scoreboard's aluminum extrusion frame. The bar has two tapped holes. The threaded rods screw into these tapped holes. The washers and nuts are used to clamp the steel angle bracket against the steel post and hold the scoreboard in place.

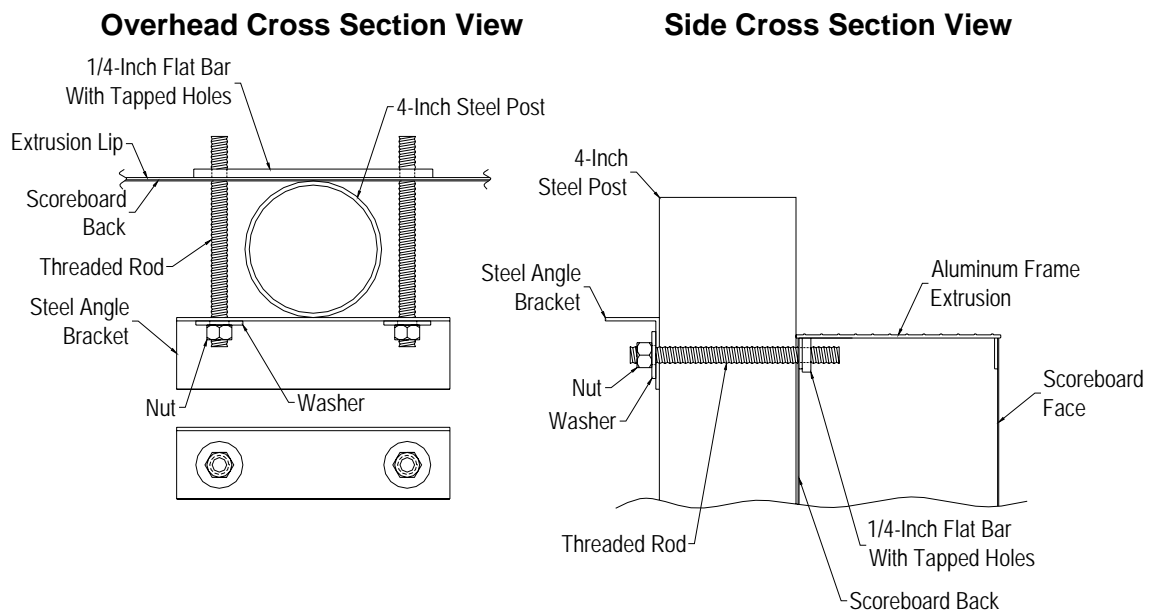

Figure 6 Standard Mounting Method

The following steps describe how to mount the scoreboard on the posts:

1. Place the scoreboard cabinet against the posts on the ground. Make sure the mounting points are aligned with the posts.
2. Screw the threaded rods into the tapped holes in the scoreboard.
3. Place a steel angle bracket over the threaded rods at mounting point #1.
4. Place a washer over each threaded rod.
5. Screw the nuts onto the threaded rods so that the bracket is loosely held in place.
6. Repeat steps 3 - 6 at the other mounting points.
7. Raise the scoreboard into place and tighten the nuts to clamp the scoreboard in place on the posts.

Note: Be sure to leave enough space on the posts above the scoreboard for the optional top sponsor panel, if purchased.

Mounting The Optional Top Sponsor Panel

Additional hardware sets are provided to attach the optional top sponsor panels, if purchased. The following steps describe how to mount the top sponsor panel on the posts:

1. Raise the top sponsor panel in place above the scoreboard. Make sure the mounting points are aligned with the posts.
2. Screw the threaded rods into the tapped holes in the top sponsor panel.
3. Place a steel angle bracket over the threaded rods at a mounting point.
4. Place a washer over each threaded rod.
5. Screw a nut onto each threaded rod so that the bracket is loosely held in place.
6. Repeat steps 3 - 5 at the other mounting points.
7. Tighten the nuts to clamp it in place on the posts.

ELECTRICAL INSTALLATION

We recommend a qualified electrician perform the needed electrical connections to ensure proper operation of the scoreboard. These connections include grounding the scoreboard, connecting the scoreboard to a power source, installing the ScoreLink 300 or the control cable, and connecting the control console.

Ground Connection

The National Electrical Code **requires** a scoreboard (electric sign) to be grounded. Grounding the scoreboard helps the scoreboard electronics operate properly and helps minimize damage if it is struck by lightning. Metal posts do **not** provide an adequate ground path. The following steps describe how to ground the scoreboard:

1. Drive one or more 5/8" x 8' copper clad ground rods in the soil near the scoreboard.
2. Connect #6 bare copper wire to the ground rods using 5/8" brass tear drop connectors.
3. Remove the rear access panel and the dome plugs on the plate below the access panel. Figure 7 shows the location of the access panel and the dome plugs.

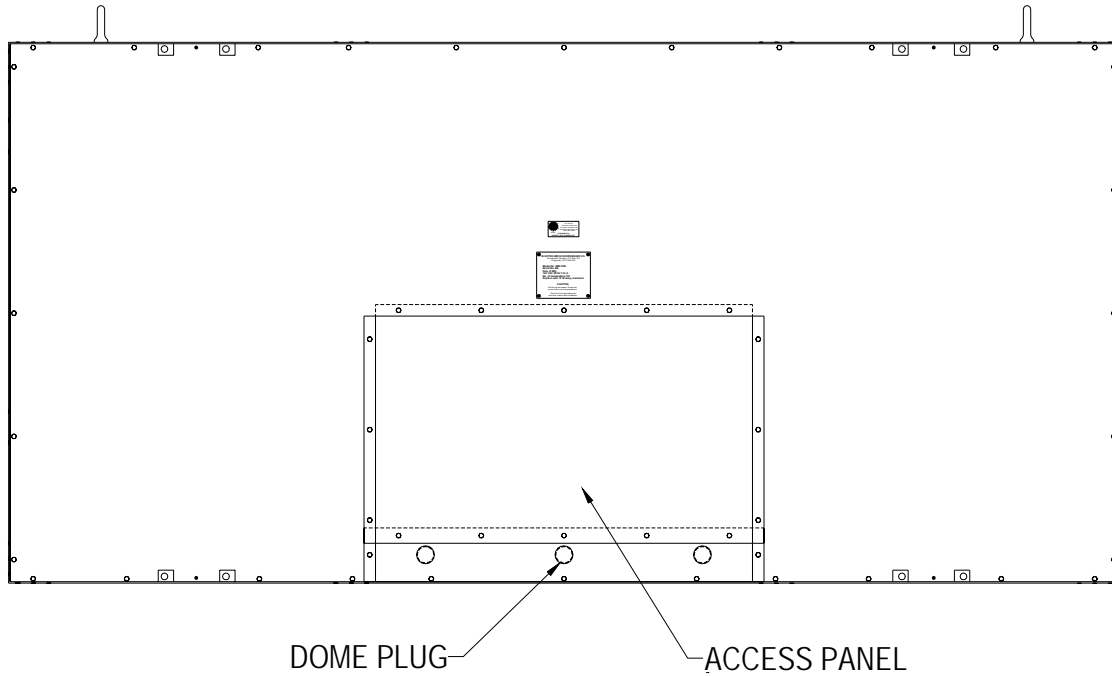

Figure 7 Rear Access Panel

4. Figure 8 shows the view behind the access panel.

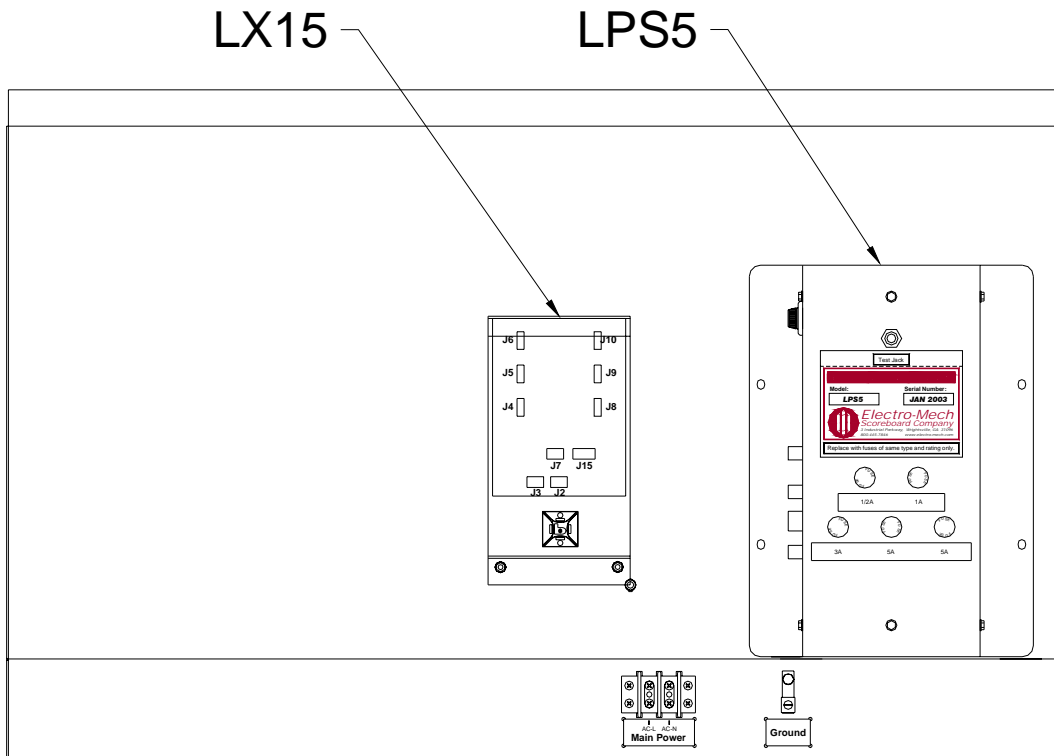

Figure 8 Access Panel Removed

5. Pass the ground conductor through the right hand hole in the plate below the access panel and connect it to the ground lug (**Ground**) on the junction chassis.

Power Connections

The scoreboard requires 120 VAC service at the scoreboard to operate properly.

Maximum power consumption of Model 1030: 120 Watts. Make sure that power cable is rated for this electrical load. Install the power cable in conduit. **Avoid** running the power cable in close proximity to the control cable. The following steps describe how to connect the scoreboard to the power source:

1. Feed the power cable through the middle hole in the plate below the access panel.
2. Crimp fork terminals to the power cable wires.
3. Connect the AC line wire and AC neutral wire to the **Main Power** terminal block on the junction chassis according to figure 9.

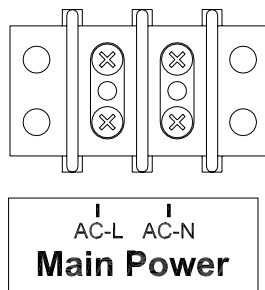

Figure 9 Power Connections

Install a power disconnect that isolates all current carrying conductors on one of the posts below the scoreboard (not the ground conductor). If a secondary switch is installed near the scorekeeper's table, it should also isolate these conductors. Place the power disconnect in the **OFF** position between games to help protect the scoreboard from lightning damage. A power disconnect on the scoreboard post also provides a convenient way of turning the scoreboard off during maintenance or repairs.

SL-230 / 330

The SL-230 / 330 RF MODEM SYSTEM is designed to eliminate the control cable between the scoreboard and the control console on Electro-Mech Scoreboard MM and MP series scoreboards as well as all LED scoreboards. If you have purchased this accessory, disregard the section of this manual titled **Control Cable Installation**. Refer to the installation manual provided for this product.

Control Cable Installation

The control cable connects the scoreboard to the control console. Install the control cable in conduit. If the cable is ever damaged, it is easier and less expensive to replace a cable in conduit. A small junction box with a ¼" stereo jack mounted on the face plate is attached to the control cable at the point of operation of the scoreboard. This junction box should be securely mounted in a clean, dry area within ten feet of the rear of the control console. Most customers order the control cable with the junction box attached. Some customers prefer to attach the junction box after the cable is installed. Those customers must solder the control cable to the ¼" stereo jack. Figure 10 shows the control cable wire connection points on the rear of the ¼" stereo jack.

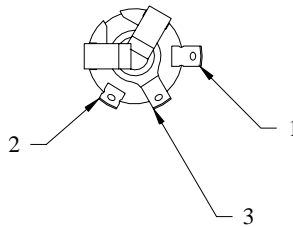

PIN 1 - BLACK WIRE
 PIN 2 - RED WIRE
 PIN 3 - SHIELD WIRE

Figure 10 ¼" Stereo Jack Wiring Diagram

The following steps describe how to connect the control cable to the scoreboard:

1. At the rear of the scoreboard feed the control cable the left hole in the plate below the access panel.
2. Crimp fork terminals to the control cable wires and the shield.
3. Connect the control cable red wire to the RED terminal of the LX15 driver board.
4. Connect the control cable black wire to the BLK terminal of the LX15 driver board.
5. Connect the control cable shield wire to the SHLD terminal of the LX15 driver board.
6. Reinstall the access panel.

Control Console Connections

The 10 ft. extension cable has two molded ¼" stereo plugs attached to it. It is used to connect the control console to the junction box. The following steps describe how to connect the control console:

1. Plug one end of the extension cable into ¼" stereo jack on the junction box.
2. Plug the other end into the ¼" stereo jack mounted on the control console back plate.
3. Plug the control console power cord into a grounded NEMA 5-15R 120 VAC receptacle.

Control Console Safety Warning

This product is equipped with a 3-wire grounding type plug, a plug having a third (grounding) pin. This plug will only fit into a grounding-type power outlet. This is a safety feature. If you are unable to insert the plug into the outlet, contact a qualified electrician to replace your obsolete outlet. Do not defeat the purpose of the grounding-type plug.

SCOREBOARD OPERATION

SCOREBOARD STARTUP

1. Place the power disconnect for the scoreboard in the **ON** position.
2. Plug one end of the 10 ft. extension cable into ¼” stereo jack on the junction box.
3. Plug the other end into the ¼” stereo jack mounted on the control console back plate.
4. Plug the control console power cord into a grounded NEMA 5-15R 120 VAC receptacle.

GAME TIME OPERATION

This scoreboard is operated with a simple 15-key control console. Figure 11 shows the keypad layout on the control console.

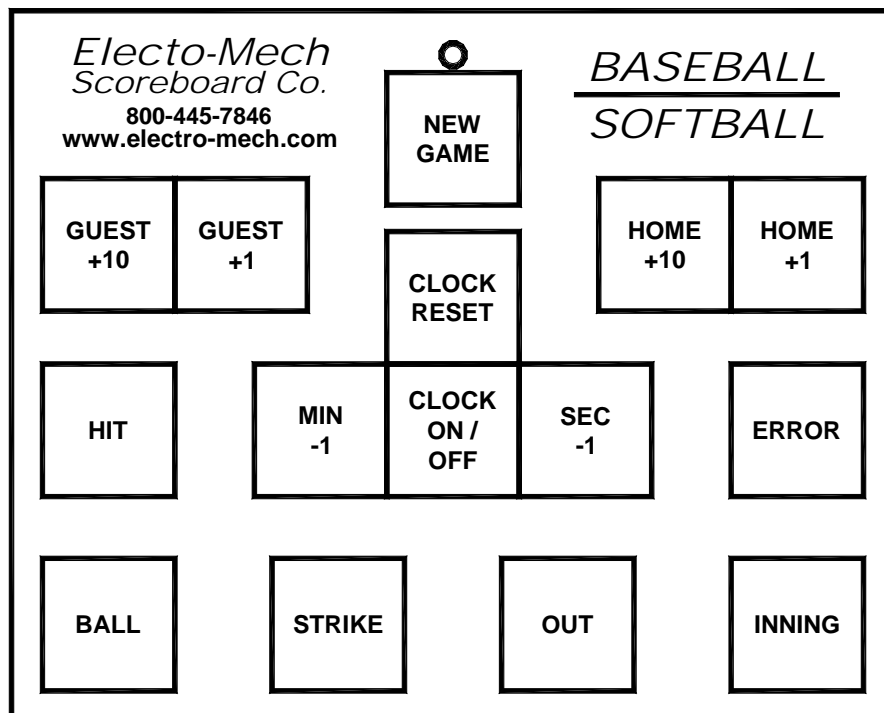

Figure 11 Keypad Layout

Control Console Key Functions

1. **GUEST +1** – This key increments the Guest score by 1.
2. **HOME +1** – This key increments the Home score by 1.
3. **GUEST +10** – This key increments the Guest score by 10.
4. **HOME + 10** – This key increments the Home scores by 10.
5. **INNING** – This key increments the Inning by 1.
6. **BALLS** – This key increments the Ball count by 1.
7. **STRIKES** – This key increments the Strike count by 1.
8. **OUTS** – This key increments the Out count by 1.
9. **NEW GAME** – This key is used with the **CLOCK RESET** key to reset all scoreboard functions. Press [NEW GAME] and, within two seconds, press [CLOCK RESET]. The HOME score, GUEST score, and INNING will display zero. The BALLS, STRIKES, and OUTS will be blanked.
10. **CLOCK RESET** – This key is used only in conjunction with the **NEW GAME** key.

The **HIT**, **ERROR**, **DEC. MIN.**, **DEC. SEC.**, and **CLOCK ON/OFF** keys are not used with the 1030 scoreboard.

You should reset the scoreboard each time that it is turned on. Test out all the functions to ensure that the scoreboard is operating properly.

SCOREBOARD SHUTDOWN

1. Place the power disconnect for the scoreboard in the **OFF** position.
2. Unplug the control console power cord.
3. Unplug the 10 ft. extension cable.
4. Store the control console in a dry location. This unit is not waterproof.

Proper scoreboard shutdown will help protect the scoreboard and control console from power surges and lightning strikes.

SERVICING THE SCOREBOARD

While your scoreboard was designed for years of trouble-free operation, some problems may occasionally occur. Electro-Mech Scoreboard Company offers onsite service in some areas. In other areas, we can help you contact an independent service technician. In areas in which service is not available from Electro-Mech Scoreboard Company, we will make every effort to answer your questions. Our trained personnel at Electro-Mech Scoreboard Company are ready to answer your questions from Monday to Friday during the hours of 8 AM to 5 PM Eastern Standard Time. Be sure to know your scoreboard model number when calling. Scoreboard replacement parts are always available. Damaged parts can usually be repaired at a significant cost savings. Our convenient toll free number is listed at the bottom of every page in this manual.

If the scoreboard turns on LEDs, but does not operate normally, make note of which functions are affected. If some LEDs either never turn on or always stay on, make note of their specific locations on the scoreboard. Refer to the COMPONENT REPLACEMENT section of this manual before changing parts.

COMPONENT REPLACEMENT

LED digits and indicators are serviced from the front of the scoreboard.

LED Digits And Indicators Replacement

The LEDs that form digits and indicators are soldered on circuit boards mounted behind metal masks. Do not attempt to replace individual LEDs. In case of a malfunction, the entire LED circuit board must be removed. **To avoid damage to the LED driver module, always turn off the power to the scoreboard when removing or replacing LED digits and indicators.** Figure 12 shows the components of a LED digit assembly. LED indicator assemblies are similar in construction.

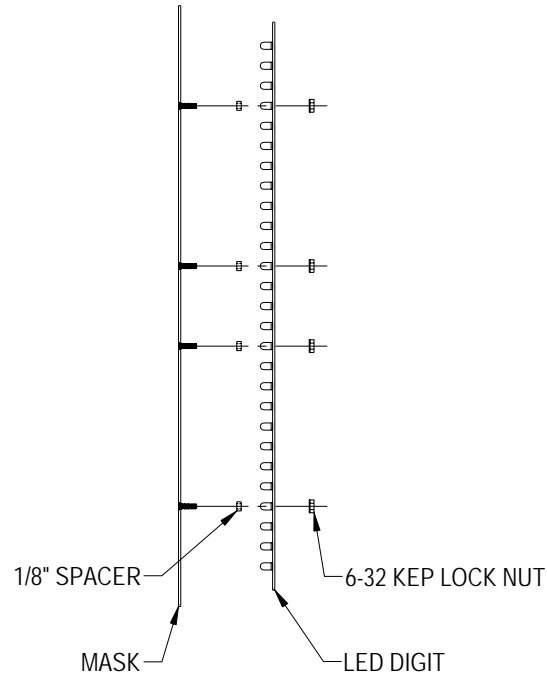

Figure 12 LED Digit Assembly

1. Remove the sheet metal screws that fasten the mask to the face of the scoreboard.
Caution: Support the mask with before removing the last screw. The ribbon cable that connects to the rear of the circuit board is not designed to support the weight of the assembly.
2. Disconnect the ribbon cable from the rear of the circuit board. **Caution: Do not let the cable hang outside of the scoreboard. It is easily cut by sharp metal edges. Damage to the ribbon cable may create short circuit paths that will damage the LX15 driver board.**
3. Place the assembly on a flat surface and remove the 6-32 kep lock nuts that hold the circuit board in place.
4. Remove the circuit board.
5. Align the mounting holes in the circuit board with the threaded studs on the mask and install the replacement digit on the mask.
6. Plug the ribbon cable onto the header on the back of the circuit board.

All other components are located behind the rear access panel. Figure 13 shows the view behind the access panel.

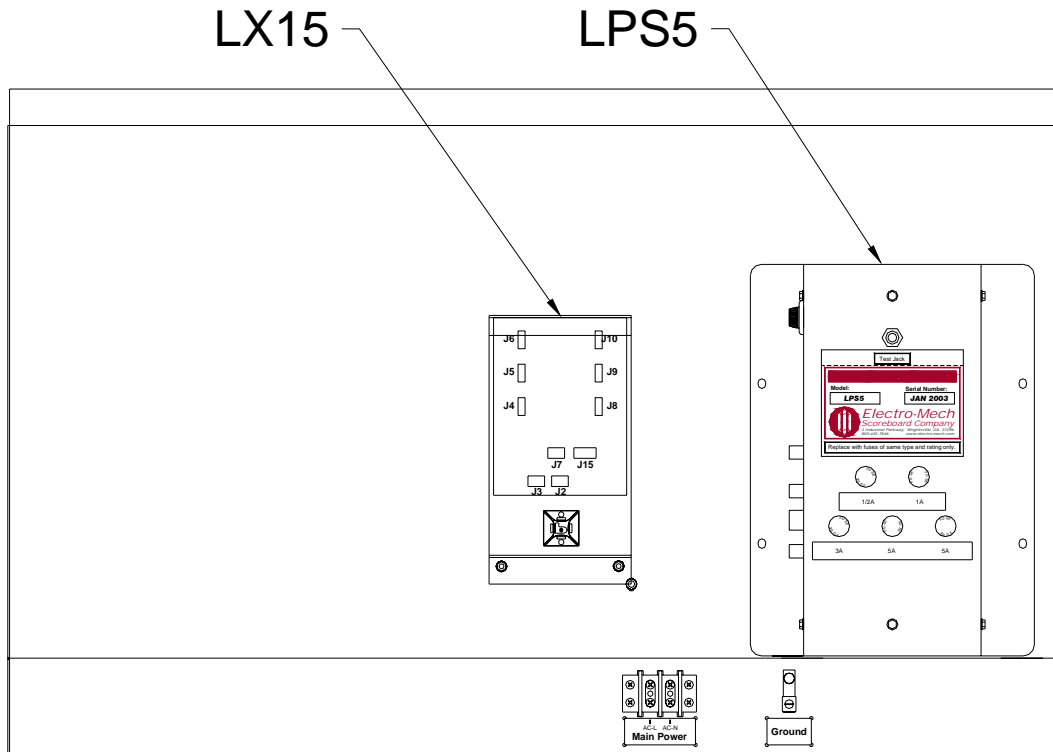

Figure 13 Access Panel Components

LX15 DRIVER BOARD FUNCTIONS

DRIVER MODULE JACK	FUNCTION #1	FUNCTION #2	FUNCTION #3
J4	HOME SCORE UNITS DIGIT		
J5	HOME SCORE TENS DIGIT		
J6	GUEST SCORE UNITS DIGIT		
J7	DRIVER MODULE DC POWER INPUT		
J8	INNINGS DIGIT		
J9	GUEST SCORE TENS DIGIT		
J10	OUTS	STRIKES	BALLS

LX Driver Board Replacement

Electrical connections to the LX driver board are made with ribbon cable polarized IDC sockets and locking ramp crimp terminal housings that mate with jacks on the circuit board. The circuit board is secured inside the scoreboard on a metal bracket with two hex nuts.

1. Unplug the electrical connections from the circuit board.
2. Remove the two hex nuts.
3. Remove the circuit board from the scoreboard.
4. Insert the replacement circuit board on the metal bracket in the scoreboard.
5. Secure the circuit board with the two hex nuts.
6. Insert the plugs into the jacks on the circuit board.

To avoid damage to the circuit board, always turn off the power to the scoreboard when removing or replacing it.

LPS5 LED POWER SUPPLY MODULE FUNCTIONS

JACK	FUNCTION
J1	120 VAC INPUT
J2	20 VDC OUTPUT TO LX15
J3	NOT USED
J4	NOT USED

Note: The test jack on the LPS5 LED power supply module is not functional in this scoreboard. Figure 14 shows the location of the fuses in the LPS5 LED Power Supply Module. The table following the figure lists the fuse ratings, functions, and part numbers.

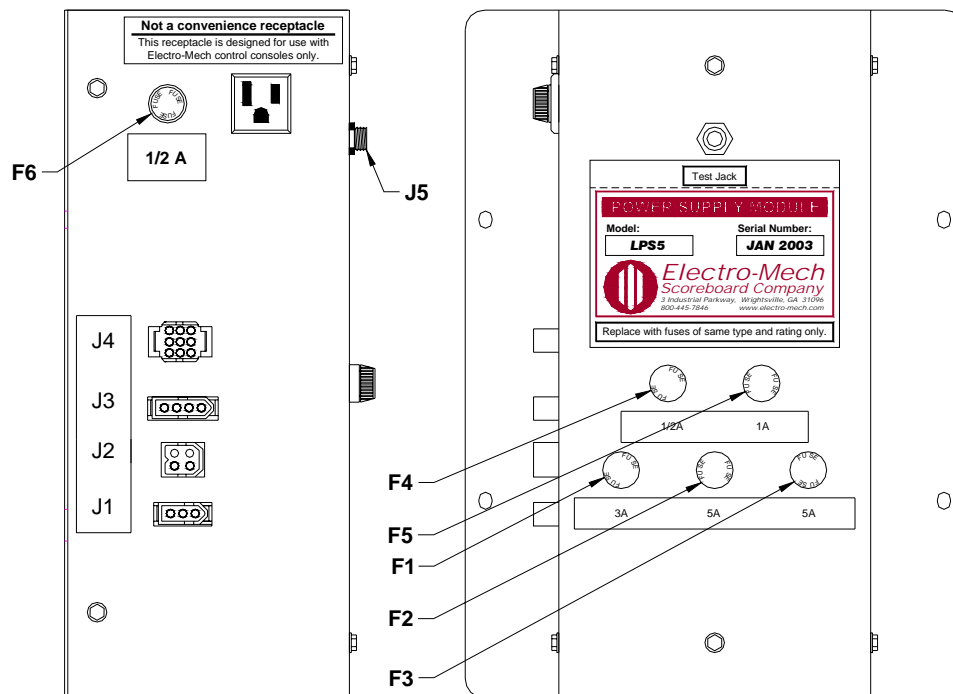

Figure 14 LPS5 Fuse Locations

LPS5 FUSES

FUSE	RATING	FUNCTION	BUSSMAN PART #
F1	3A 250V	TRANSFORMER PRIMARY	AGC-3
F2	10A 250V	LX DRIVER BOARD J7	AGC-10
F3	10A 250V	NOT USED	AGC-10
F4	1/2A 250V	NOT USED	AGC-1/2
F5	1A 250V	NOT USED	AGC-1
F6	1/2A 250V	120 VAC ELECTRICAL RECEPTACLE	AGC-1/2

Note: Other manufacturer's fuses may be substituted for the Bussmann fuses.

LED Power Supply Module Replacement

Electrical connections to the LPS5 LED Power Supply Module are made with keyed plugs that mate with jacks on the left side of the module. The module is secured inside the scoreboard with four machine screws.

1. Disconnect the plugs from the jacks on the module.
2. Remove the four screws.
3. Remove the module from the scoreboard.
4. Insert the replacement module in the scoreboard.
5. Secure the module with the four screws.
6. Insert the plugs into the jacks on the side of the module.

To avoid damage to the module, always turn off the power to the scoreboard when removing or replacing it.

ELECTRO-MECH SCOREBOARD CO. FIVE YEAR LIMITED WARRANTY

THE ELECTRICAL COMPONENTS OF ALL ELECTRO-MECH SCOREBOARDS ARE GUARANTEED FOR A PERIOD OF FIVE (5) YEARS FROM THE DATE OF INVOICE AGAINST DEFECTS IN WORKMANSHIP OR MATERIAL AND WILL BE REPLACED OR REPAIRED WITHOUT COST TO THE OWNER PROVIDED THE EQUIPMENT OR PARTS ARE RETURNED POSTAGE-PAID TO THE FACTORY IN WRIGHTSVILLE, GA. SHIPPING BACK TO THE OWNER WILL BE VIA UPS GROUND SERVICE EXCEPT WHEN AIR OR SPECIAL METHOD OF RETURN IS SPECIFIED BY THE OWNER, IN WHICH CASE SHIPPING WILL BE FREIGHT COLLECT.

EXCLUDED FROM THIS WARRANTY ARE FUSES.

THIS WARRANTY DOES NOT INCLUDE LABOR CHARGES INCURRED IN THE REMOVAL OF COMPONENT PARTS, SERVICE CALLS, OR DAMAGES RESULTING FROM IMPROPER INSTALLATION, IMPROPER OPERATION, OR PROBLEMS CAUSED BY ANY REPAIR, ALTERATION OR MODIFICATION OF THE SCOREBOARD NOT PERFORMED BY ELECTRO-MECH.

EQUIPMENT WHICH IS SUBJECTED TO ACCIDENT, NEGLIGENCE, ABUSE, MISUSE OR OTHER NATURAL DISASTERS, INCLUDING BUT NOT LIMITED TO FIRE, WIND, LIGHTNING, OR FLOOD, IS NOT COVERED BY THIS GUARANTEE.